

# USER'S MANUAL

**BY SOLARDIREKT24 GMBH**

**Tel: 06732 / 608 99 99**

**Fax: 06732 / 608 99 98**

**E-Mail: [info@solardirekt24.de](mailto:info@solardirekt24.de)**

**ECO R32**

**FULL DC INVERTER A+++**

**MULTI FUNCTIONAL AIR SOURCE HEAT PUMP**

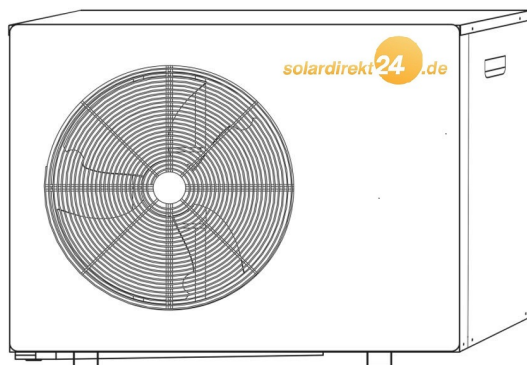

This manual is applicant for the modes of:

**EUROTHERM HP008-M2, EUROTHERM HP012-M2,**

**EUROTHERM HP016-M2 (220~240V/50HZ/single phase)**

**EUROTHERM HP016-M3 (380~415V/50HZ/three phases)**

Thanks very much for purchasing our heat pump, please keep and read the manual carefully before you install heat pump.

## Note

1. Please read the instruction manual carefully before installation or operation.
2. The heat pump must be installed by a professional installer.
3. Please follow the instruction manual strictly when installing the heat pump
4. If any update on the product, this instruction manual is subject to change without notice
5. If the heat pump is installed where is vulnerable to lightning strikes, it is necessary to take lightning protection measures; if the heat pump is turned off in the winter, please be sure to drain the water in the system to prevent cold water from swelling and causing system damage.

## Contents

<b>User Instruction</b> -----	<b>1</b>
<b>Operation Instructions</b> -----	<b>8</b>
<b>Dimension</b> -----	<b>15</b>
<b>Installation</b> -----	<b>17</b>
<b>Commissioning</b> -----	<b>27</b>
<b>Maintenance</b> -----	<b>28</b>
<b>Trouble Analysis</b> -----	<b>29</b>
<b>Specification</b> -----	<b>32</b>
<b>After-sale Service</b> -----	<b>33</b>

## User Instructions

1. Please use an electrical leakage switch, otherwise, there may be electric shock, fire, etc.

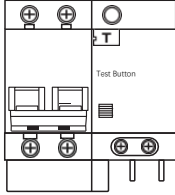

2. Make sure that the leakage protection switch is securely connected. If the wiring is not secure, it may cause electric shock, heat, or fire.

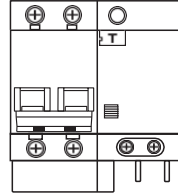

3. Do not operate with a wet hand, otherwise, there may cause electric shock.

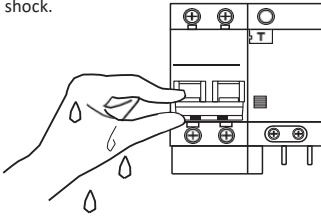

4. Do not insert your fingers or any stick into the inside of the ventilation area, otherwise, harm will be caused.

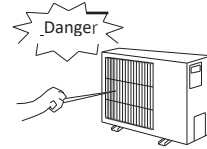

### 1. Precautions

Please make sure that you have read this manual before using our air source heat pump. In the “User Information” chapter, “User Information” provides essential safety information. Please be sure to follow the instruction strictly.



#### Warning

Wrong operations are likely to cause serious consequences such as death, serious injury, or major accidents



#### Note

Improper operation may result in a safety accident, damage to the machine, or affect the function of the machine.

Please read the labels on the machine carefully. If abnormal conditions such as abnormal noise, odor, smoke, temperature rise, electric leakage, fire, etc. are found during use, please cut off the power immediately and contact our local customer service center or dealer in time to repair it. Contact the local fire and emergency department immediately if necessary.



## Warning

- 1) This Machine is not allowed to be installed by the user. A professional installer must install it, Otherwise cause safety accidents or affects the machine's performance.
- 2) Without professional guidance, non-professionals are not allowed to disassemble the machine. Otherwise, accidents or damage may be caused to the device.
- 3) Do not use or store flammable materials such as hair spray, paint, gasoline, alcohol, etc., around the machine. Otherwise, fire may be caused.
- 4) The machine's main power switch should be placed where that child cannot reach to prevent children from playing with the power switch.
- 5) Do not spray water or other liquids on the machine. Otherwise, danger may occur.
- 6) Do not touch the machine with wet hands. Otherwise, it may cause an electric shock.
- 7) In thunderstorms, please disconnect the main power switch off the machine. Otherwise, lightning may cause danger or damage to the device.
- 8) The machine needs to use a separate power switch to avoid sharing the same circuit with other electrical appliances, supply the power to the machine vice the specified power cable, and use the proper breaker with the electric leakage protection required.
- 9) The machine must be installed with a specified grounding wire. Do not connect the grounding wire to the gas pipe, water pipe, lightning conductor, or telephone, and the machine must be grounded reliably to avoid any electric shock.
- 10) Do not disconnect the power supply when the machine is running.
- 11) When the machine is not used for a long time, please disconnect the main power switch to avoid accidents.
- 12) If the ambient temperature is below 0 °C, it is forbidden to cut off the power supply. If the power is turned off unexpectedly under these conditions, drain the water inside the pipeline.



## Note

- 1) Do not put your hands or other objects into the air outlet of the machine. Otherwise, the fan running at high speed may cause harm.
- 2) Do not remove the fan cover. Otherwise, the fan running at high speed may cause injury to you or others.
- 3) Lightning and other sources of electromagnetic radiation may have a remarkable effect on the machine. Turn off the power and then restart the device if it does affect it.
- 4) Make sure the water supply is frequent. Otherwise, the machine may be damaged.
- 5) Do not restart the machine frequently. Otherwise, the device may be damaged.
- 6) The operating parameters of the machine and the set value of the protection device have been selected by the manufacturer. Users should not change the set value arbitrarily and do not short the wire of the protection device. Otherwise, the machine may be damaged due to improper protection.
- 7) To avoid the freezing of the water system pipeline when the machine is deactivated in an environment below 0 °C, please keep the machine standby state. If the device is out of service

---

for a long time, it is recommended that the user drain the water out of the water system and disconnect the power supply.

- 8) Please perform regular maintenance on the machine as required by the instructions to ensure the device is in good operating condition.

## 2. Refrigerant Precaution

- 1) Do not use means to accelerate the defrosting process or to clean, other than those recommended by the manufacturer.
- 2) The appliance shall be stored in a room without continuously operating ignition sources (for example open flames, an operating gas appliance, or an operating electric heater)
- 3) Do not pierce or burn.
- 4) Be aware that refrigerants may not contain an odor.
- 5) Appliance shall be installed, operated, and stored in a room with a floor area larger than X m<sup>2</sup>
- 6) The installation of pipe-work shall be kept to a minimum of X m<sup>2</sup>
- 7) Spaces where refrigerant pipes shall be in compliance with national gas regulations.
- 8) Servicing shall be performed only as recommended by the manufacturer.
- 9) The appliance shall be stored in a well-ventilated area where the room size corresponds to the room area as specified for operation.
- 10) All working procedures that affect safety means shall only be carried out by competent persons.

## 3. Requirement of Flammable Refrigerant

- 1) Transport of equipment containing flammable refrigerants: Compliance with the transport regulations
- 2) Marking of equipment using signs: Compliance with local regulations
- 3) Disposal of equipment using flammable refrigerants: Compliance with national regulations
- 4) Storage of equipment/appliances: The storage of equipment should be in accordance with the manufacturer's instructions.
- 5) Storage of packed (unsold) equipment: Storage package protection should be constructed such that mechanical damage to the equipment inside the package will not cause a leak of the refrigerant charge. The maximum number of pieces of equipment permitted to be stored together will be determined by local regulations.
- 6) Information on servicing:
  - i. Checks to the area  
Prior to beginning work on systems containing flammable refrigerants, safety checks are necessary to ensure that the risk of ignition is minimized. For repair to the refrigerating system, the following precautions shall be complied with prior to conducting work on the system.
  - ii. Work Procedure  
Work shall be undertaken under a controlled procedure so as to minimize the risk of flammable gas or vapor being present while the work is being performed.
  - iii. General Work Area  
All maintenance staff and others working in the local area shall be instructed on the nature of the work being carried out. Work in confined spaces shall be avoided. The area around the workspace shall be sectioned off. Ensure that the conditions within the area have been made safe by control of flammable material.
  - iv. Checking for the presence of refrigerant  
The area shall be checked with an appropriate refrigerant detector prior to and during work, to

---

ensure the technician is aware of potentially flammable atmospheres. Ensure that the leak detection equipment being used is suitable for use with flammable refrigerants, i.e. non-sparking, adequately sealed or intrinsically safe.

v. Presence of fire extinguisher

If any hot work is to be conducted on the refrigeration equipment or any associated parts, appropriate fire extinguishing equipment shall be available to hand. Have a dry powder or CO2 fire extinguisher adjacent to the charging area.

vi. No ignition sources

No person carrying out work in relation to a refrigeration system that involves exposing any pipework that contains or has contained flammable refrigerant shall use any sources of ignition in such a manner that it may lead to the risk of fire or explosion. All possible ignition sources, including cigarette smoking, should be kept sufficiently far away from the site of installation, repairing, removal, and disposal, during which flammable refrigerant can possibly be released to the surrounding space. Prior to work taking place, the area around the equipment is to be surveyed to make sure that there are no flammable hazards or ignition risks. "No Smoking" signs shall be displayed.

vii. Ventilated area

Ensure that the area is in the open or that it is adequately ventilated before breaking into the system or conducting any hot work. A degree of ventilation shall continue during the period that the work is carried out. The ventilation should safely disperse any released refrigerant and preferably expel it externally into the atmosphere.

viii. Checks to the refrigeration equipment

Where electrical components are being changed, they shall be fit for the purpose and to the correct specification. At all times the manufacturer's maintenance and service guidelines shall be followed. If in doubt consult the manufacturer's technical department for assistance. The following checks shall be applied to installations using flammable refrigerants:

--The charge size is in accordance with the room size within which the refrigerant containing parts are installed;

--The ventilation machinery and outlets are operating adequately and are not obstructed;

--If an indirect refrigerating circuit is being used, the secondary circuit shall be checked for the presence of refrigerant;

--Marking of the equipment continues to be visible and legible. Markings and signs that are illegible shall be corrected;

--Refrigeration pipes or components are installed in a position where they are unlikely to be exposed to any substance which may corrode refrigerant-containing components unless the components are constructed of materials that are inherently resistant to being corroded or are suitably protected against being so corroded.

ix. Checks to electrical devices

Repair and maintenance to electrical components shall include initial safety checks and component inspection procedures. If a fault exists that could compromise safety, then no electrical supply shall be connected to the circuit until it is satisfactorily dealt with. If the fault cannot be corrected immediately but it is necessary to continue operation, an adequate temporary solution shall be used. This shall be reported to the owner of the equipment so all parties are advised.

Initial safety checks shall include:

- That capacitor is discharged: this shall be done in a safe manner to avoid the possibility of sparking;
- That there no live electrical components and wiring are exposed while charging, recovering, or purging the system;
- That there is continuity of earth bonding.

- 
- 7) Repairs sealed components:
- a) During repairs to sealed components, all electrical supplies shall be disconnected from the equipment being worked upon prior to any removal of sealed covers, etc. If it is absolutely necessary to have an electrical supply to equipment during servicing, then a permanently operating form of leak detection shall be located at the most critical point to warn of a potentially hazardous situation.
  - b) Particular attention shall be paid to the following to ensure that by working on electrical components, the casing is not altered in such a way that the level of protection is affected. This shall include damage to cables, an excessive number of connections, terminals not made to original specification, damage to seals, incorrect fitting of glands, etc. Ensure that apparatus is mounted securely. Ensure that seals or sealing materials have not degraded such that they no longer serve the purpose of preventing the ingress of flammable atmospheres. Replacement parts shall be in accordance with the manufacturer's specifications.  
NOTE: The use of silicone sealant may inhibit the effectiveness of some types of leak.
- 8) Repair to intrinsically safe components  
Do not apply any permanent inductive or capacitance loads to the circuit without ensuring that this will not exceed the permissible voltage and currently permitted for the equipment in use. Intrinsically safe components are the only types that can be worked on while living in the presence of a flammable atmosphere. The test apparatus shall be at the correct rating. Replace components only with parts specified by the manufacturer. Other parts may result in the ignition of refrigerant in the atmosphere from a leak.
- 9) Cabling  
Check that cabling will not be subject to wear, corrosion, excessive pressure, vibration, sharp edges or any other adverse environmental effects. The check shall also take into account the effects of aging or continual vibration from sources such as compressors or fans.
- 10) Detection of flammable refrigerants  
Under no circumstances shall potential sources of ignition be used in the searching for or detection of refrigerant leaks. A halide torch (or any other detector using a naked flame) shall not be used.
- 11) Leak detection methods  
The following leak detection methods are deemed acceptable for systems containing flammable refrigerants.  
Electronic leak detectors shall be used to detect flammable refrigerants, but the sensitivity may not be adequate or may need re-calibration. (Detection equipment shall be calibrated in a refrigerant-free area.) Ensure that the detector is not a potential source of ignition and is suitable for the refrigerant used. Leak detection equipment shall be set at a percentage of the LFL of the refrigerant and shall be calibrated to the refrigerant employed and the appropriate percentage of gas (25 % maximum) is confirmed.  
Leak detection fluids are suitable for use with most refrigerants but the use of detergents containing chlorine shall be avoided as the chlorine may react with the refrigerant and corrode the copper pipe-work.
- 12) Removal and evacuation  
When breaking into the refrigerant circuit to make repairs – or for any other purpose – conventional procedures shall be used. However, it is important that best practice is followed since flammability is a consideration. The following procedure shall be adhered to:
- Remove refrigerant;
  - Purge the circuit with inert gas;
  - Evacuate;
  - Purge again with inert gas;
  - Open the circuit by cutting or brazing.

---

The refrigerant charge shall be recovered into the correct recovery cylinders. The system shall be “flushed” with OFN to render the unit safe. This process may need to be repeated several times. Compressed air or oxygen shall not be used for this task.

Flushing shall be achieved by breaking the vacuum in the system with OFN and continuing to fill until the working pressure is achieved, then venting to the atmosphere, and finally pulling down to a vacuum. This process shall be repeated until no refrigerant is within the system. When the final OFN charge is used, the system shall be vented down to atmospheric pressure to enable work to take place. This operation is absolutely vital if brazing operations on the pipe-work are to take place.

Ensure that the outlet for the vacuum pump is not close to any ignition sources and there is ventilation available.

### 13) Charging procedures

In addition to conventional charging procedures, the following requirements shall be followed.

--Ensure that contamination of different refrigerants does not occur when using charging equipment. Hoses or lines shall be as short as possible to minimize the amount of refrigerant contained in them.

--Cylinders shall be kept upright.

--Ensure that the refrigeration system is earthed prior to charging the system with refrigerant.

--Label the system when charging is complete (if not already).

--Extreme care shall be taken not to overfill the refrigeration system.

--Prior to recharging the system, it shall be pressure tested with OFN. The system shall be leak tested on completion of charging prior to commissioning. A follow-up leak test shall be carried out prior to leaving the site.

### 14) Decommissioning

Before carrying out this procedure, it is essential that the technician is completely familiar with the equipment and all its detail. It is recommended good practice that all refrigerants are recovered safely. Prior to the task being carried out, an oil and refrigerant sample shall be taken in case analysis is required prior to re-use of reclaimed refrigerant. It is essential that electrical power is available before the task is commenced.

a) Become familiar with the equipment and its operation.

b) Isolate system electrically.

c) Before attempting the procedure ensure that:

- Mechanical handling equipment is available, if required, for handling refrigerant cylinders;
- All personal protective equipment is available and being used correctly;
- The recovery process is supervised at all times by a competent person;
- Recovery equipment and cylinders conform to the appropriate standards.

d) Pump down refrigerant system, if possible.

e) If a vacuum is not possible, make a manifold so that refrigerant can be removed from various parts of the system.

f) Make sure that cylinder is situated on the scales before recovery takes place.

g) Start the recovery machine and operate in accordance with manufacturer's instructions.

h) Do not overfill cylinders. (No more than 80 % volume liquid charge).

i) Do not exceed the maximum working pressure of the cylinder, even temporarily.

j) When the cylinders have been filled correctly and the process completed, make sure that the cylinders and the equipment are removed from the site promptly and all isolation valves on the equipment are closed off.

k) Recovered refrigerant shall not be charged into another refrigeration system unless it has been cleaned and checked.

### 15) Labelling

Equipment shall be labeled stating that it has been decommissioned and emptied of refrigerant.



---

The label shall be dated and signed. Ensure that there are labels on the equipment stating the equipment contains flammable refrigerant.

16) Recovery

When removing refrigerants from a system, either for servicing or decommissioning, it is recommended good practice that all refrigerants are removed safely. When transferring refrigerant into cylinders, ensure that only appropriate refrigerant recovery cylinders are employed. Ensure that the correct number of cylinders for holding the total system charge is available. All cylinders to be used are designated for the recovered refrigerant and labeled for that refrigerant (i.e. special cylinders for the recovery of refrigerant). Cylinders shall be complete with a pressure relief valve and associated shut-off valves in good working order. Empty recovery cylinders are evacuated and, if possible, cooled before recovery occurs. The recovery equipment shall be in good working order with a set of instructions concerning the equipment that is at hand and shall be suitable for the recovery of flammable refrigerants. In addition, a set of calibrated weighing scales shall be available and in good working order. Hoses shall be complete with leak-free disconnect couplings and in good condition. Before using the recovery machine, check that it is in satisfactory working order, has been properly maintained, and that any associated electrical components are sealed to prevent ignition in the event of a refrigerant release. Consulting manufacturer if in doubt.

The recovered refrigerant shall be returned to the refrigerant supplier in the correct recovery cylinder, and the relevant Waste Transfer Note arranged. Do not mix refrigerants in recovery units and especially not in cylinders. If compressors or compressor oils are to be removed, ensure that they have been evacuated to an acceptable level to make certain that flammable refrigerant does not remain within the lubricant. The evacuation process shall be carried out prior to returning the compressor to the suppliers. Only electric heating to the compressor body shall be employed to accelerate this process. When oil is drained from a system, it shall be carried out safely.

## 4. Other Safety

Thank you for choosing a heat pump. This is a heat pump capable of providing the ideal comfort for your home, always with a suitable hydraulic installation. The unit is an air source heat pump for space heating/cooling and a sanitary water heater for houses, apartment blocks, and small industrial premises. Outdoor air is used as a heat source creating free energy to heat your home.

This manual forms an essential part of the product and it must be given to the user. Read the warnings and recommendations in the manual carefully, as they contain important information on the safety, use, and maintenance of the installation.

This heat pump must be installed by qualified personnel only, in accordance with the legislation in force and following the manufacturer's instructions.

The start-up of this heat pump and any maintenance operations must be carried out only by qualified personnel only.

Incorrect installation of this heat pump could result in damage to people, animals or property, and the manufacturer will not be held liable in such cases.

The following safety precautions should always be taken into account:

- 1) Be sure to read the following WARNING before installing the unit.
- 2) Be sure to observe the cautions specified here as they include important items related to safety.
- 3) After reading these instructions, be sure to keep them in a handy place for future reference.
- 4) Equipment shall contain the following identification:

Inflammable “  ” Read Carefully “  ” Professional Recycling “  ”

# Operation Instruction

## 1. Control Panel

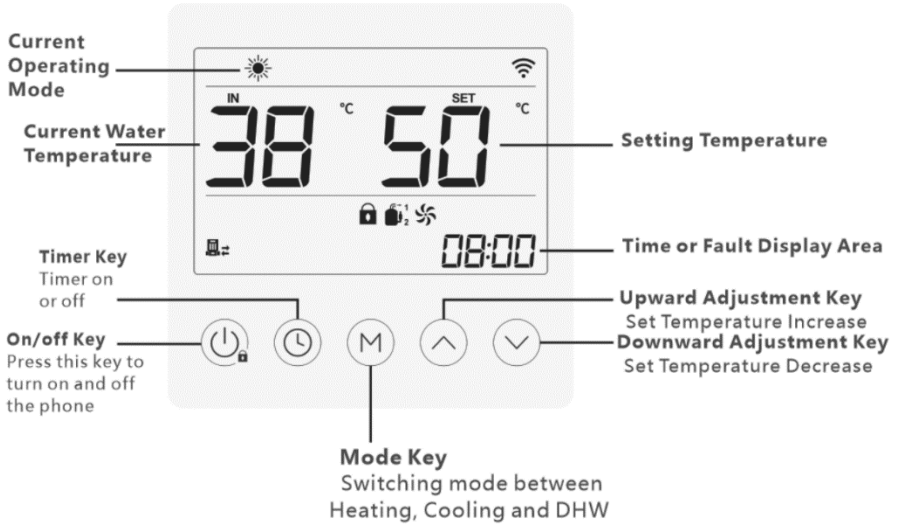

## 2. Operation Instruction

### 2.1 Turn On/Off

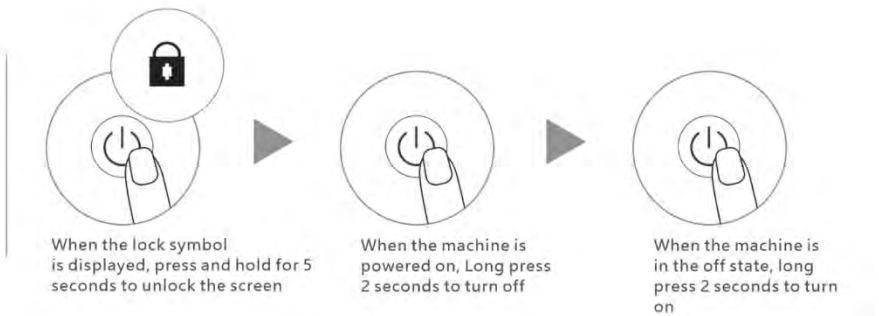

## 2.2 Mode

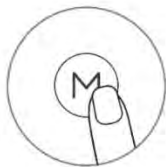

Press M button to switch heating, cooling and floor heating modes under the power-on condition

## 2.3 Temperature Regulation



Press the down button to raise Set temperature



Press the up button to lower Set temperature

If there is no operation for 5 seconds or press the on/off button will automatically save the set temperature and return to the main interface

## 2.4 Time Settings



Press the clock button for 1 second to enter Current time setting



Press the clock button again hour area flashes



Combine with up and down keys Adjust the value



Press the clock button again Enter the minute time setting



Press the clock button again to flash the minute area

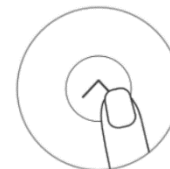

Combine with up and down keys to adjust the value

If there is no operation for 5 seconds or press the on/off button, it will automatically save the set temperature and return to the main interface

## 2.5 Timed Power on

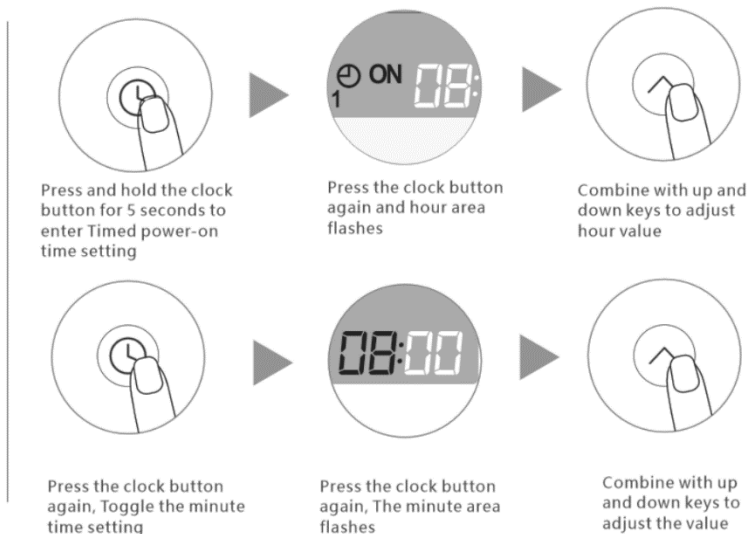

If there is no operation for 5 seconds or press the on/off button, it will automatically save the set temperature and return to the main interface

## 2.6 Status Query

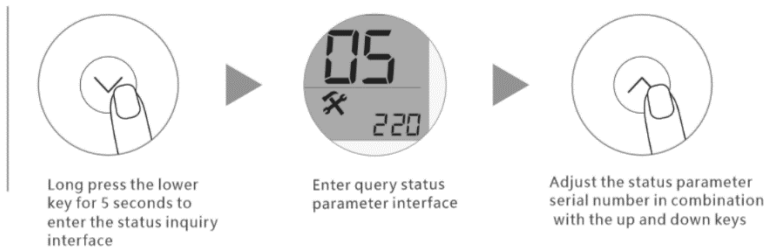

## 2.7 ECO Mode

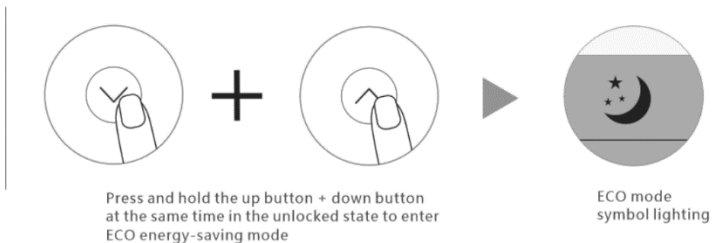

## 2.8 Water pump forced evacuation mode

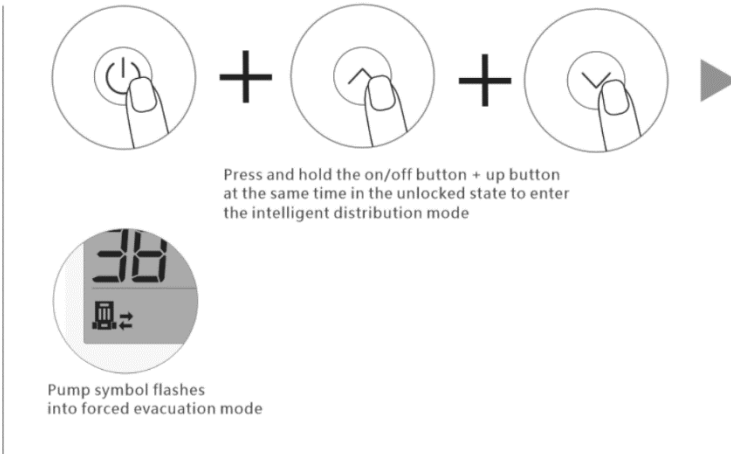

## 3. Temperature and Climate Curve Setting

### 3.1 Enable Climate Temperature Curve

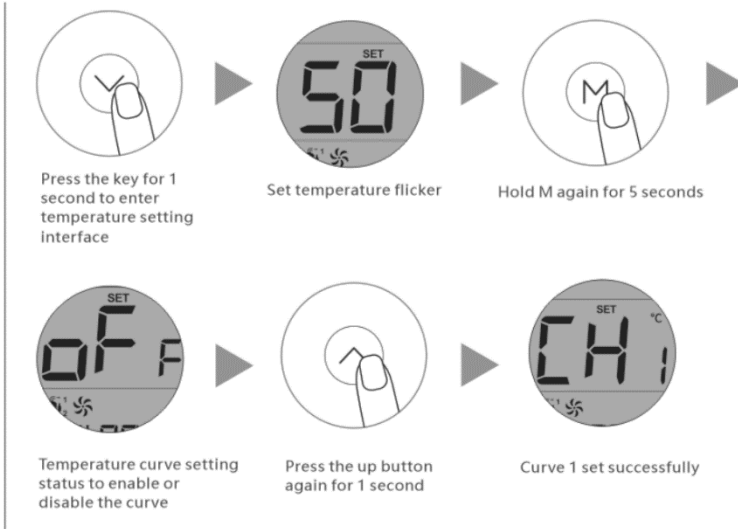

When the climate temperature curve function is enabled, the user can select one of the eight curves in the main interface; curve 4 is the default curve, and curve 6 is the ECO energy-saving curve.

---

## 4. Wi-Fi Setting

### 4.1 Software Download and Account Registration

- 4.1.1 Search for  Smart Life in the app store on the mobile phone, and download and install it.
- 4.1.2 Users who do not have an account can apply by clicking the "Create New User" function on the login page.
- 4.1.3 Create a new account → Enter your cell phone number or email address, → get the verification code → to enter the verification code → set the password → complete, in the following order.
- 4.1.4 After registration is complete, you need to create a family: create a family, → set the family name → set the location → to add a room → ultimately, in the following order.
- 4.1.5 Click on the device name to enter the main interface of the device
- 1) Family name, which allows access to family management.
  - 2) Adding devices.
  - 3) Added room; click on it to view the devices added to that room.
  - 4) Room management.

### 4.2 Connection (Intelligent Mode)

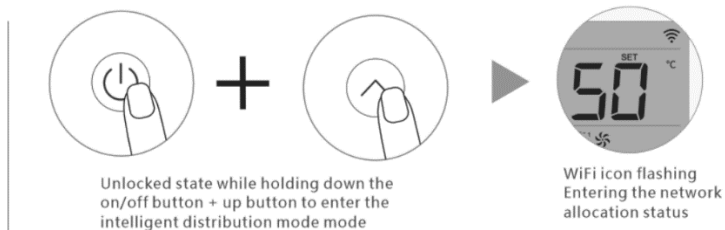

#### Step 1

Open the "Smart Life" APP, login to the main interface, click the "lift" icon in the upper right corner to add devices or "Add Device" in the interface, enter the device type selection, and select "Smart Heat Pump (Wi-Fi)" in the "Main Appliance" device, enter the add device interface.

#### Step 2

Select Smart Heat Pump (Wi-Fi) and enter into the Wi-Fi connection interface, enter the Wi-Fi password that the phone has been connected to (must be the same as the Wi-Fi connection to the phone), click Next, and confirm that the line controller has selected the intelligent distribution mode, "  " icon is fast-flashing, click "Confirm that the indicator is flashing, then start adding devices directly, click the "lift" icon to add devices.

Note: The icon flashes slowly when the Wi-Fi module is connected to the Wi-Fi hotspot.

#### Step 3

The system prompts "Add Device Successfully" and then the network is successfully distributed. Click on the icon in this interface to change the device name, select the device installation location (living room, main bedroom), and click Finish to enter the main interface of device operation.

### 4.3 Connection (AP Mode)

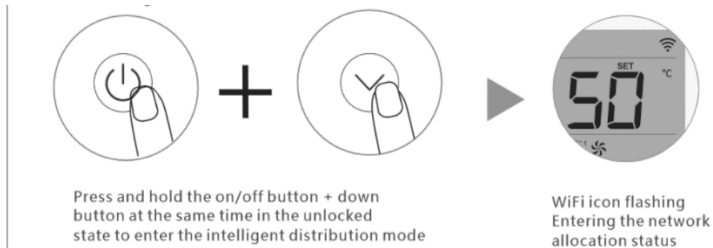

**Step 1 and Step 2:** Be consistent with the Intelligent Mode

#### Step 3

Select innovative heat pump (Wi-Fi) after entering into the Wi-Fi connection interface, enter the phone has been connected to the (Wi-Fi) password (must be consistent with the Wi-Fi connected to the phone), click next, confirm that the line controller has selected AP distribution mode, an icon in the slow flashing state “”, click “Confirm that the indicator is in slow flashing,” then connect the phone Wi-Fi to the device hotspot (as shown below), confirm that the connection hotspot is correct to continue to the next step then directly begin to connect the device interface, find the device → registers to the cloud → device initialization is complete.

Note: When the wire Wi-Fi module is connected to the Wi-Fi hotspot, the icon “” slows flashing.

**Step 4** The same as the Intelligent Mode

Note: If the connection fails, manually enter the AP network configuration mode again and repeat the preceding steps to connect again.

### 4.4 Software Function Operation

4.4.1 A device is automatically bound to a virtual gateway. The "My Home Heat Pump" (device name, which can be changed) operation page is displayed.

Buy a ticket to enter the device operation page of "My Home Heat Pump" by clicking on "My Home Heat Pump" in the "All Devices" screen of smart Life.

4.4.2 Modify device name and modify device location information Click "Name" to rename the device name and "Location" to alter the device location.

### 4.5 Device Sharing

Share bound devices in the following sequence:

- 1) After successful sharing, the list is added to display the shared person.
- 2) To delete the shared user, long-press the selected user, and the deletion interface will pop up, click "Delete"
- 3) User interface operations are as follows:
- 4) Enter the account of the shared user and click "Finish" to display the newly shared history in the list of successful sharing
- 5) The interface of the shared person is as follows. The shared device received is displayed. Click in to operate and control the device.

## Operation Parameter Query

Query Code	Description	Range
1	Compressor Running Frequency	0 ~ 99 Hz
2	Fan Motor Running Frequency	0 ~ 99 Hz
3	Main EEV Opening	0 ~ 480 P
4	EVI EEV Opening	0 ~ 480 P
5	AC Input Voltage	0 ~ 500 V
6	AC Input Current	0 ~ 50 A
7	Compressor Phase Current	0 ~ 50 A
8	Compressor IPM Mould Temperature	-50 ~ 200 °C
9	Condensing Temperature	-50 ~ 200 °C
10	Vaporization Temperature	-50 ~ 200 °C
11	Outdoor Ambient Temperature	-50 ~ 200 °C
12	Outdoor Coil Temperature	-50 ~ 200 °C
13	Indoor Coil Temperature	-50 ~ 200 °C
14	Gas Suction Temperature	-50 ~ 200 °C
15	Gas Exhaust Temperature	-50 ~ 200 °C
16	Water Inlet Temperature	-50 ~ 200 °C
17	Water Outlet Temperature	-50 ~ 200 °C
18	Economizer Inlet Temperature	-50 ~ 200 °C
19	Economizer Outlet Temperature	-50 ~ 200 °C
20	Dialer Value	0 ~ 15

**Display Fault:** When the machine has a fault, the fault is flashing in the timing area and the fault code is displayed cyclically; when the fault is eliminated, the standard display is restored.



# Dimension

## 1. Dimension

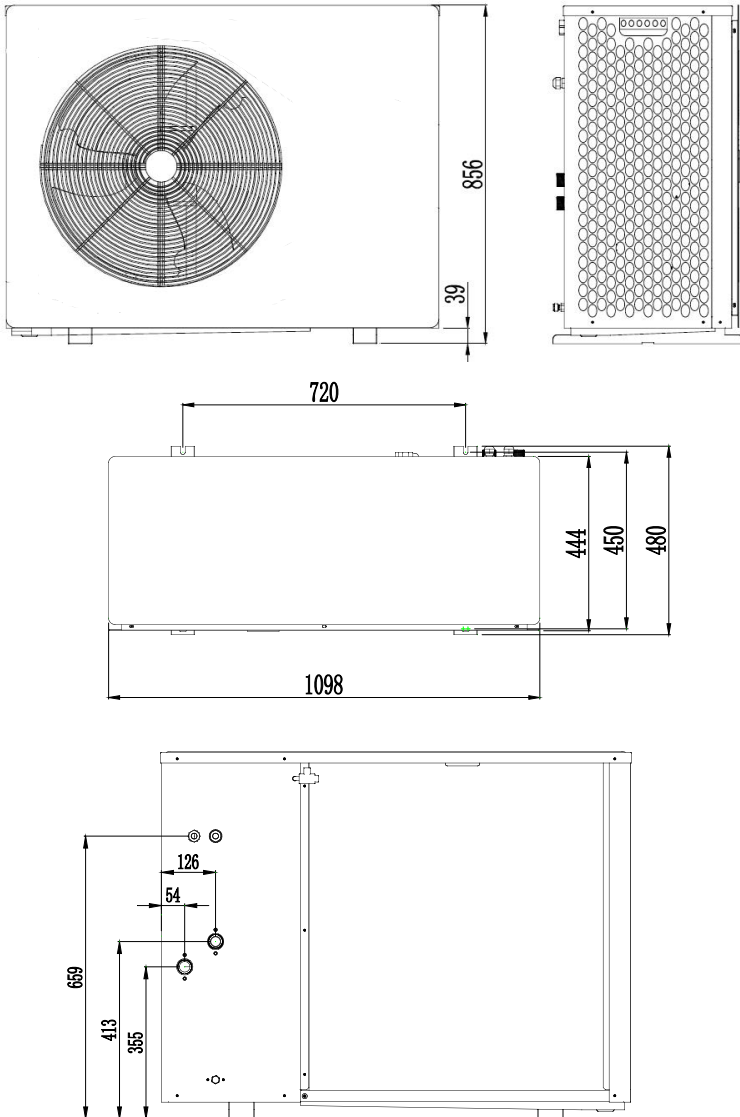

## 2. Explosive Diagram

- |                      |                         |                        |
|----------------------|-------------------------|------------------------|
| ① Front panel        | ⑪ Sensor fixing clip    | ⑳ Plate heat exchanger |
| ② Left side panel    | ⑫ Water proof connector | ㉑ Mounting panel       |
| ③ Evaporator         | ⑬ Connecting panel 2    | ㉒ Base                 |
| ④ Reactor            | ⑭ Connecting panel 3    | ㉓ DC compressor        |
| ⑤ Electrical cabinet | ⑮ Right panel           | ㉔ Mounting board       |
| ⑥ Connecting panel 1 | ⑯ Pipeline group        | ㉕ Middle septum        |
| ⑦ Top panel          | ⑰ Gas-liquid separator  | ㉖ Motor support        |
| ⑧ Heat exchanger     | ⑱ Accumulator           | ㉗ DC motor             |
| ⑨ Mounting panel     | ㉙ Condenser fixed plate | ㉘ Fan                  |
| ⑩ Right back panel   | ㉚ DC water pump         |                        |

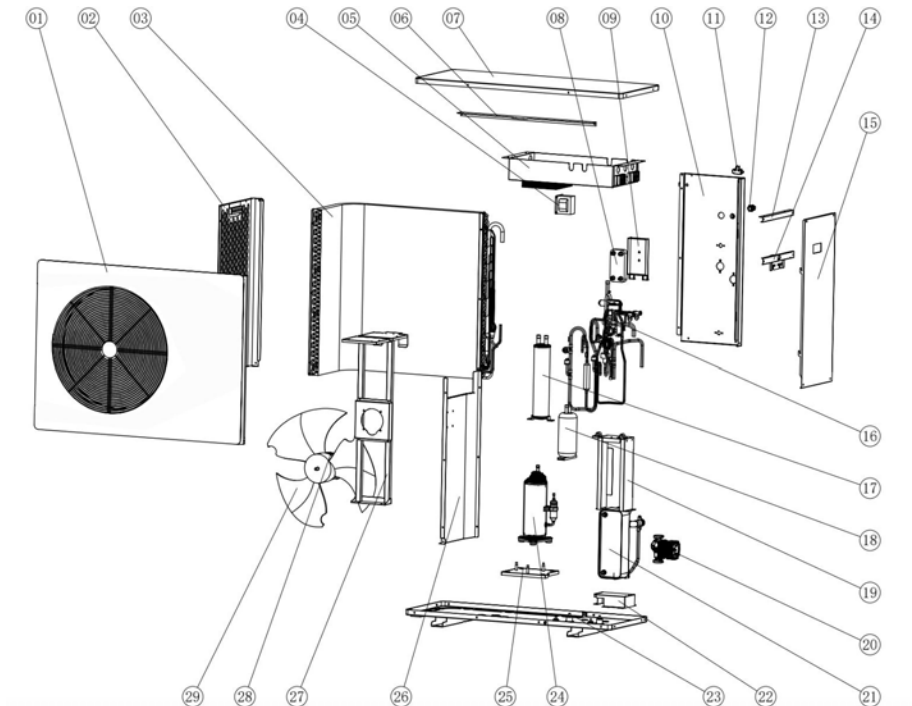

# Installation

## 1. Installation Preparation

### 1.1 Install The Required Tools (Self-Provided)

Number	Tool	Number	Tool
1	Level	10	Saw
2	Electric Hammer	11	Flat Blade Screwdriver
3	Adjustable Wrench	12	Cross Screwdriver
4	Needle-nose Plier	13	Copper Tube Knife
5	Impulse Drill	14	PP-R Tube Knife
6	Ruler	15	PP-R Tube Heat Melting Device
7	Torque Wrench	16	Compound Gauge
8	Hexagonal Wrench	17	Vacuum Pump
9	Hammer	18	Electronic Balance

### 1.2 Connecting Wires, Insulation Materials, PP-R Pipe, And Connector

- a) The material and thickness of the insulation pipe meet the specified requirements. Otherwise, heat loss and condensation will be caused.
- b) Please refer to this manual's "Electrical Installation" description section for wire size selection.

Model	The water inlet/outlet size
MMHP-016B1	G1(male)
MMHP-016B2	G1(male)

### 1.3 Other Installation Materials

- a) Fix the pipe bracket and pipe clamp of the connecting pipe
- b) Wire threading pipe and pipe clamp
- c) Insulating tape, raw tape
- d) Expansion bolt
- e) Mounting bracket

## 2. Heat Pump Installation

- 2.1 The machine installation space meets the following schematic requirements to ensure regular air circulation and maintenance;
- 2.2 The location of the machine should be kept away from heat, steam, or flammable gases;
- 2.3 Do not install the machine in places with strong wind or dust;
- 2.4 Do not install the machine where it is often passed through the air suction side and air exhaust side;
- 2.5 The installation position of the machine should be adequately drained to the nearby sewer.

---

## Heat Pump Installation Space Diagram

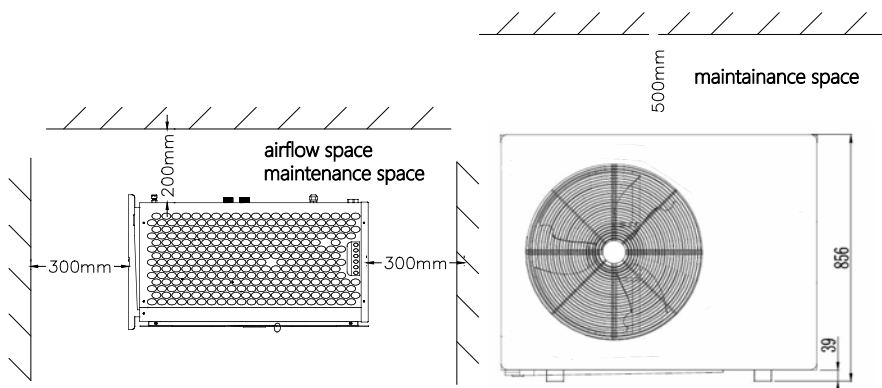

### Note

Installation In The Following Locations May Cause The Machine To Malfunction:

1. A place with more oil;
2. Wet place
3. Seaside saline-alkali area;
4. Special environmental conditions;
5. High-frequency facilities such as wireless equipment, welding machines, and medical equipment.

### 3. Outdoor Unit Specific Installation Steps

- 3.1 Install the unit on a solid surface such as concrete, and the load-bearing cover or mounting bracket must meet the strength requirements;
- 3.2 Fasten the outdoor unit to the mounting bracket with bolts and nuts and keep it level;
- 3.3 If installed on a wall or a roof, the bracket must be firmly fixed to prevent damage caused by an earthquake or strong wind;
- 3.4 The positioning dimension of the outdoor unit installation base is 810\*394mm. It is required to install four-position foot bolts with a diameter of 10mm—at the bottom of the installation of the outdoor unit. The inch recommendation is 1200\*450mm.

---

## Installation Precautions

1. The unit should be installed so that the inclination of any vertical surface does not exceed 5 degrees;
2. Do not install the outdoor unit directly on the ground;
3. The strength of the ordinary air-conditioning bracket may not apply to the unit. Please design or select the frame according to the weight of the team;
4. If the mainframe is installed and fixed on the open balcony and the roof, it is necessary to lift the unit. Pay attention to the following points when lifting:
  - 4.1 Please use four or more soft slings to lift the handling unit;
  - 4.2 To avoid scratching and deformation of the surface of the unit, please install the guard plate on the surface of the team during lifting and loading;
  - 4.3 Before final installation, it is necessary to check whether the foundation is correct or not, in case it is wrong with the actual object.

## 4. User Water System Installation

- 4.1 The Installation Of The Water System Must Meet The Following Principles:
  - 4.1.1 Pipe length is as short as possible;
  - 4.1.2 Pipe diameter must meet the requirements of the unit;
  - 4.1.3 The elbows on the waterway are as few as possible, and the elbow radius is as large as possible;
  - 4.1.4 The thickness of the water pipe insulation layer meets the specified requirements;
  - 4.1.5 Dust and debris should not enter the pipeline system as much as possible;
  - 4.1.6 The unit must be fixed before the piping system can be installed.

## Remarks:

1. Hydraulic calculation must be carried out after the primary water pipe selection is completed. If the waterside pipeline resistance is more excellent than the selected pump lift, the larger water pump must be re-selected, or the water pipe must be increased in size;
2. When multiple units are connected in parallel, the primary and circulating water pumps must be selected as appropriate according to the hydraulic calculation requirements.

# Piping Instruction

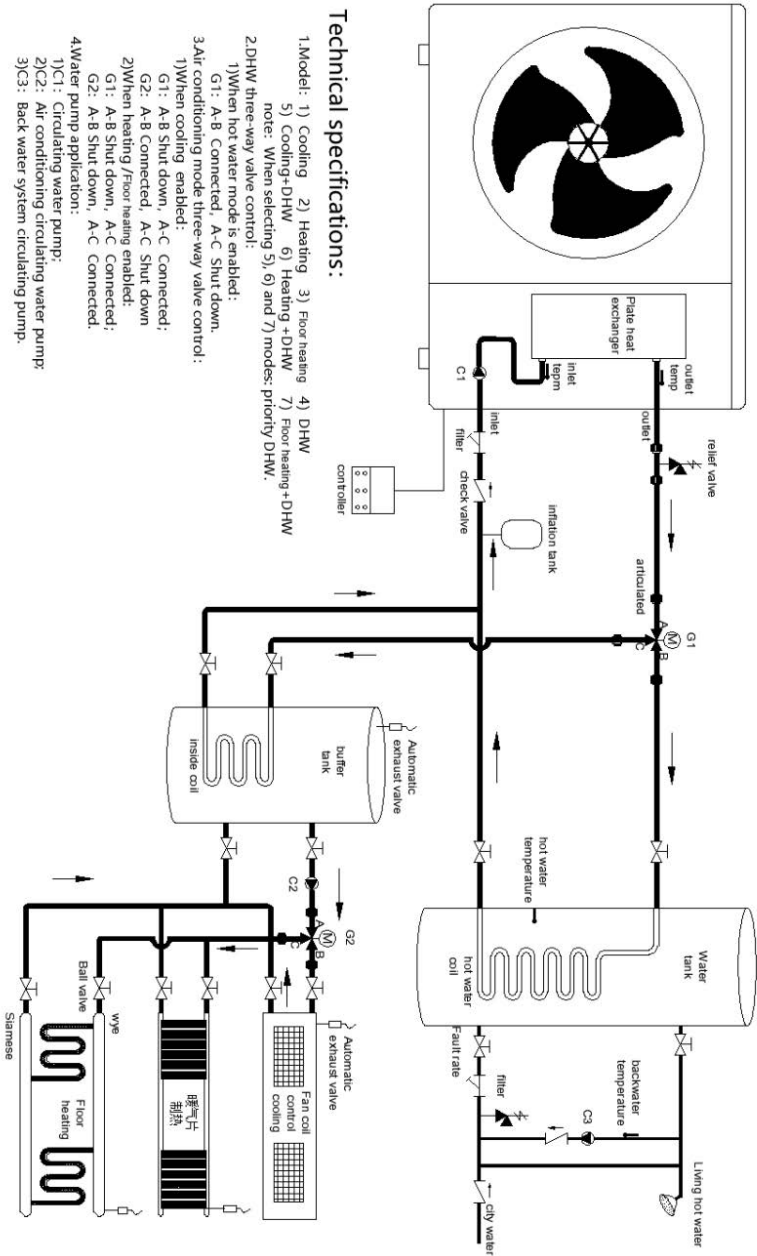

## Technical specifications:

- 1.Model: 1) Cooling 2) Heating 3) Floor heating 4) DHW
- 5) Cooling+DHW 6) Heating+DHW 7) Floor heating+DHW
- note: When selecting 5), 6) and 7) modes: priority DHW.
- 2.DHW three-way valve control:
  - 1)When hot water mode is enabled:
    - G1: A-B Connected, A-C Shut down.
  - 3.Air conditioning mode three-way valve control:
    - 1)When cooling enabled:
      - G1: A-B Shut down, A-C Connected;
      - G2: A-B Connected, A-C Shut down
    - 2)When heating/Floor heating enabled:
      - G1: A-B Shut down, A-C Connected;
      - G2: A-B Shut down, A-C Connected.
- 4.Water pump application:
  - 1)C1: Circulating water pump;
  - 2)C2: Air conditioning circulating water pump;
  - 3)C3: Back water system circulating pump.

---

## Remarks:

1. The same piping design is allowed to distribute the water evenly.
2. The system must be equipped with an automatic water supply valve, and the highest point of the water system must be equipped with an automatic pressure relief valve;
3. The drain valve shall be installed at the bottom of the pipeline to facilitate drainage;
4. The pressure relief valve is installed at the highest point of the system pipeline, and the terminal of the water pipe must have an expansion diameter;
5. Normal working water capacity can ensure normal defrosting in winter (ensure that the water capacity per kW exceeds 10L);
6. The machine has been equipped with a water flow switch; users do not need to install one more;
7. To facilitate the maintenance of the machine, a pressure gauge is required to be installed for the outlet pipe of the device;
8. If the compartment controls the floor heating, and the number of the manifolds in the smallest area is less than or equal to 2, please install the differential pressure bypass valve according to the schematic diagram;

### 4.2 Water Quality Requirements By The Machine

- 4.2.1 When water quality is not good, it will produce some scale and sediment such as sand. Therefore, the water used must be filtered and softened with soft water equipment before it flows into the heat pump water system;
- 4.2.2 Please analyze the water quality before using the machine, such as PH value, conductivity, chloride ion concentration, sulphur ion concentration, etc.

PH	Water Hardness	Conductivity	S	Cl	Nh4
7~8.5	<50ppm	<200vV/cm(25°C)	N/A	<500ppm	N/A
So4	Si	Iron content	Na	Ca<	
<50ppm	<30ppm	<0.3ppm	N/A	<50ppm	

### 4.3 Water Pipeline Installation Instructions

- 4.3.1 Install all water pipelines;
- 4.3.2 Check if any water leaks in the pressurized pipelines;
- 4.3.3 Clean the water pipelines.

### 4.4 Water Pipeline Feed-Water And Pipeline Emptying Steps:

- 4.4.1 Open the pressure relief valve on the water distributor and all valves;
- 4.4.2 Feed the water at the pipe filling port;
- 4.4.3 During the feed-water process, it is necessary to observe if the pressure relief valve or the drain valve has water overflow, and if there is water overflow, it means that the water in the system has been filled;
- 4.4.4 Close the pressure relief valve, and then look at the water pressure gauge. If the pressure value is more than 0.15Mpa, please close the feed-water valve and complete the water drain.

---

## 5. Selection and Installation of Water System Accessories

### 5.1 Selection Of Circulating Pump

- 5.1.1 The machine must be installed with a circulating pump to be used. The heat pump provides the power port of the circulating pump (single-phase power supply). Please refer to the circuit diagram for wiring. The maximum power of the circulating pump is not allowed to exceed 1.5 kW.
- 5.1.2 Please select the circulating pump according to the actual lift required, and the flow must be guaranteed to meet the requirements of the machine nameplate.

### 5.2 Selection Of Auxiliary Electric Heater

- 5.2.1 The user can select the auxiliary electric heater if needed; however, the machine only provides the port connected with a signal wire to control the auxiliary electric heater.
- 5.2.2 Professionals must install the installation of auxiliary electric heaters.

### 5.3 Selection Of Water Flow Switch: The machine has a built-in flow switch, so it does not require one more water flow switch.

### 5.4 Other Optional Accessories Recommended

Accessories	Description	Remark
Buffer Tank	60 L or Bigger	
Expansion Tank	5 L	Only Pressurized System
Pressure Gauge	1.5 Mpa	
Safety Valve	0.3 Mpa	Only Pressurized System

## 6. Electrical Installation

All wiring and grounding must comply with local electrical codes.



### Note

1. The specification label should be carefully checked to ensure that the wiring meets the specified requirements and is correctly wired according to the wiring diagram;
2. The auxiliary electric heater must be equipped with an independent current circuit breaker and leakage protector;
3. The power supply must meet the requirements of the machine and must be reliably and effectively wired;
4. Wires should not be in contact with copper pipes, compressors, motors, or other operating components;
5. Do not change the internal wiring of the machine without permission. Otherwise, the seller will not commit any responsibility;
6. Do not change the internal wiring of the machine without permission. Otherwise, the seller will not commit any responsibility;
7. Do not send power before the wiring is completed to avoid personal injury;
8. The supply voltage should vary within  $\pm 10\%$  of the standard value.
9. Electrical specifications:



Module	MMHP-008B1			MMHP-012B1			MMHP-016B1			MMHP-020B1		
	HP	HP-E1	HP-E1-E2	HP	HP-E1	HP-E1-E2	HP	HP-E1	HP-E1-E2	HP	HP-E1	HP-E1-E2
Maximum consumption	10	30	50	17	37	57	25	45	65	12	32	52
Min.wire section(mm²)	1.5	6	10	2	6	10	4	10	10	2	6	10
Recommended fuse	25A	32A	63A	25A	40A	63A	32A	63A	75A	25A	40A	63A
Recommended cable type	H05W-U3G(protected in pipe)											

### Power Cable And Signal Wire Connection Instruction

1. Remove the machine’s front cover and connect the wire to the corresponding terminal block according to the electrical wiring diagram to confirm that the connection is secure.
2. Secure the cable with the wire clamp and install the service plate.
3. Do not connect the wrong line. Otherwise, it will cause electrical failure or even damage the machine.
4. The type and rating of the fuse are based on the specifications of the corresponding controller or fuse cover.
5. The power cable must be selected and installed by a professional installer. When the installer chooses the power cable, the power cable should not be lighter than the neoprene armoured cord (line 57 of IEC 60245). For specific power cable specifications, see the electrical specifications.
6. If the user’s power distribution capacity is insufficient or the power cord (copper core wire) is not configured as required, the machine cannot be started or operated normally. The seller will not take any responsibility.

### Motherboard Output Definitions

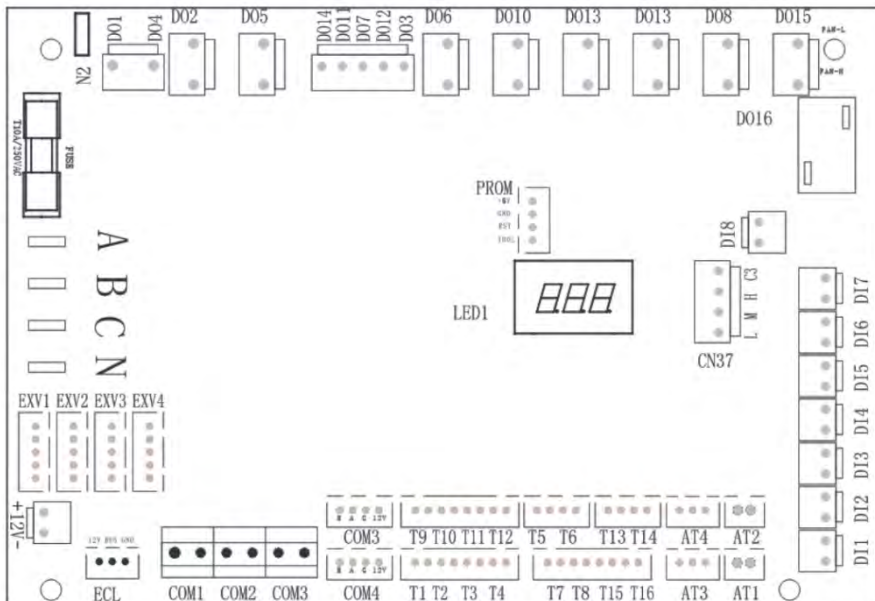

Seq.	Port	Description	Seq.	Port	Description
1	D01	Hot Water Electric Heating	35	A13	Low-Pressure Sensors
2	D02	Four-Way Valve	36	T1	Outer Coil Temperature
3	D03	Liquid Injection Valve	37	T2	Return Air Temperature
4	D04	Reservation	38	T3	Exhaust Temperature
5	D05	Reservation	39	T4	Cooling Coil Temperature
6	D06	Return Water Valve	40	T5	Economizer Inlet Temperature
7	D07	Crankshaft Heating	41	T6	Economizer Outlet Temperature
8	D08	Chassis Heating	42	T7	Outdoor Ambient Temperature
9	D09	Heating Electric Heating	43	T8	Water Inlet Temperature
10	D010	Hot Water Valve Off	44	T9	Reservation
11	D011	Hot Water Valve On	45	T10	Reservation
12	D012	Air-Conditioning Valve Open	46	T11	Reservation
13	D013	Air-Conditioning Valve Off	47	T12	Reservation
14	D014	Enthalpy Valve	48	T13	Return Water Temperature
15	D015	Low Wind (AC)	49	T14	Freeze Protection Temperature
16	D016	High Wind (AC)	50	T15	Water Discharge Temperature
17	D017	Circulating Water Pump	51	T16	Water Tank Temperature (Hot Water)
18	C2	Public Side1	52	COM3	Drive Module
19	C1	Public Side2	53	COM4	LCD In-Line Controller
20	D18	Medium Voltage Switch 1	54	COM3	Reservation
21	D17	Reservation	55	COM2	Uplink Monitoring And Control
22	D16	Linkage Switch	56	COM1	Module Cascade
23	D15	Reservation	57	ECL	Extension Modules
24	D14	Reservation	58	12V	DC 12V Power Supply
25	D13	Water Flow Switch	59	EXV1	EEV Main Valve
26	D12	Low Voltage Switch	60	EXV2	Auxiliary Valves
27	D11	High Voltage Switch	61	EXV3	Reservation
28	C3	Water Level Public End	62	EXV4	Reservation
29	H	High Water Level (Hot Water)	63	N	Power Input Zero Line
30	M	Medium Water Level (Hot Water)	64	C	Power Input T-Phase
31	L	Low Water Level (Hot Water)	65	B	Power Input S-Phase
32	A12	Reservation	66	A	Power Input R-Phase
33	A11	Reservation	67	LED1	8-Bit Dialing Code
34	A14	High-Pressure Sensors			

## Expansion Board Output Definition

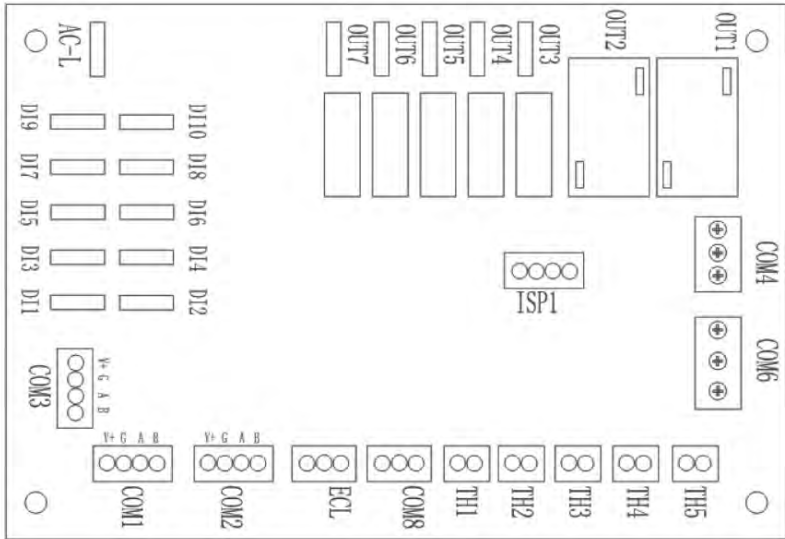

Seq	Port	Description	Seq	Port	Description
1	OUT1	Circulating Water Pump	18	D16	Forced Hot-Water Switch
2	OUT2	Hot Water Electric Heating	19	D15	Gnd
3	OUT3	Air-Conditioning Valve Off	20	D14	Linkage Switch
4	OUT4	Air-Conditioning Valve On	21	D13	Gnd
5	OUT5	Hot Water Valve On	22	D12	Water Flow Switch
6	OUT6	Hot Water Valve Off	23	D11	Gnd
7	OUT7	Reservation	24	TH1	Water Inlet Temperature
8	D08	Chassis Heating	25	TH2	Water Outlet Temperature
9	D09	Electric Heating For Heating	26	TH3	Water Tank Temperature
10	D010	Hot Water Valve Off	27	TH4	Cooling Coil Temperature
11	D011	Hot Water Valve On	28	TH5	Freeze Protection Temperature
12	D012	Air-Conditioning Valve On	29	COM8	Water Flow Meter
13	D013	Air-Conditioning Valve Off	30	ECL	Serial Communication
14	D110	Forced Cooling Switch	31	COM2	Rs485
15	D19	Gnd	32	COM2	Rs485
16	D18	Forced Heating Switch	33	COM1	Rs485
17	D17	Gnd	34	AC-L	Firewire Input

## Wire Diagram

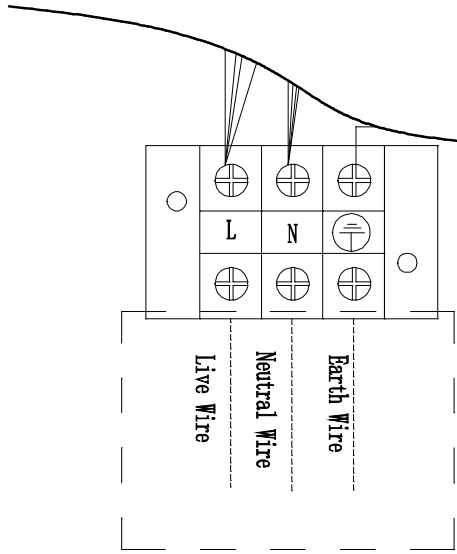

Power Supply: 220V/~50Hz

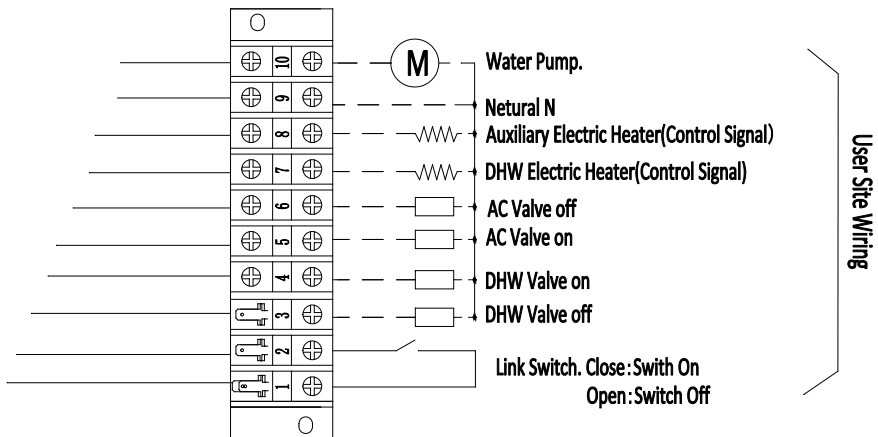

---

## Commissioning

### 1. Precautions Before Commissioning

- 1.1 Is the machine adequately installed?
- 1.2 Is the wiring and pipe correct?
- 1.3 Whether the water pipelines are empty or not?
- 1.4 Whether the heat insulation has been perfected?
- 1.5 Is the ground wire connected reliably?
- 1.6 Whether the power supply voltage matches the rated voltage of the machine?
- 1.7 Is there any obstacle in the air inlet and outlet of the machine?
- 1.8 Is the safety valve installed correctly?
- 1.9 Whether the leakage protector can operate effectively?
- 1.10 The system water pressure is not less than 0.15 MPa, and the maximum pressure cannot exceed 0.5 MPa;
- 1.11 In winter, the machine needs to be energized at least 24 hours before the operation, as the compressor needs to be preheated.

### 2. Commissioning

Use the controller to control the machine and check the following items according to the instruction manual: (If there is any fault, please find out the faults and reasons described in the manual and eliminate them)

- 2.1 Is the controller regular?
- 2.2 Is the function key of the controller regular?
- 2.3 Is the drainage normal?
- 2.4 Test whether the heating mode and cooling mode are working correctly;
- 2.5 Is the outlet water temperature average?
- 2.6 Whether there is vibration and abnormal sound during operation?
- 2.7 Does the generated wind, noise, and condensate affect neighbours?
- 2.8 Is there a refrigerant leakage?

### 3. Operation and Debugging

- 3.1 About 3mins of protection  
Due to the self-protection of the compressor, the machine cannot be restarted again within 3 mins.
- 3.2 Feature of heating operation  
If the ambient temperature is too high during operation, the outdoor motor may run low or stop.
- 3.3 In the case of heating operation, when the unit has frost formation, the defrosting procedure (about 2-8 minutes) is automatically performed to improve the heating effect. The outdoor motor stops running during the "defrost" operation.

---

### 3.4 Power Outage

If there is a power outage during operation, the machine will stop running. Before the power outage, the controller automatically memories the ON/OFF status of the device. After re-powering, the controller will send an ON/OFF signal to the device according to the state of memory before the power outage to ensure that the device recovers from the previous status from abnormal power failure.

### 3.5 Heating Capacity

Because the heat pump absorbs heat from the outside, the heating capacity will be reduced once the outdoor temperature is lowered.

### 3.6 Electric Leakage Protector

After the unit has been running for some time (usually one month), the leakage protector needs to press the test button under the closed energized state to check whether the performance of the leakage protector is regular and reliable (the leakage protector should be disconnected once every time the test button is pressed). If the accident is not found, the test can be sent once. If it is not working, the cause should be found, and if necessary, the action characteristic test should be carried out. After checking, it is confirmed that the leakage protector itself has failed. It should be replaced or repaired in time.

### 3.7 Working Temperature Range

To use the machine correctly, please operate under the following conditions, outdoor temperature: -30 °C ~ 45 °C for heating mode, 16 °C ~ 45 °C for cooling mode.

### 3.8 Antifreeze in the winter

When the ambient temperature is below 0 °C, it is strictly forbidden to cut off the power. If there is an unexpected power failure under this condition, please drain the water from the heat.

## Maintenance

1. Please check whether the grounding wire is connected reliably before use. If there is any abnormality, please replace it in time.
2. Please check the air inlet and outlet of the outdoor unit regularly for blockage.
3. Professionals must clean the outdoor unit heat exchanger, casing, and water circulation piping. It is recommended to clean the filter of the waterside filter regularly (cleaning is usually done once a year, depending on the actual situation).
4. Regularly check that the safety valve is working correctly, and ensure that the drain can be drained normally by manually turning the red knob (usually once every three months, depending on the actual situation).
5. Regularly (usually once a year, but depending on the actual situation) check whether the water pipe joint and the refrigerant connection pipe are leaking or leaking refrigerant (there are oil leakage marks). If there is any leak, please contact the seller.
6. The machine can only be serviced by a professional. The device must be cut off before contacting the wiring part.
7. Once the machine will not be used for a long time, please cut off the power, drain the water in the pipeline, and close each valve.

## Trouble Analysis

Error code	Fault Description	Failure Causes
E01	Wrong-Phase Protection	Power supply phase sequence error
E02	Power Supply Lack Of Phase	The power supply is out of phase
E03	Outside Water Flow Switch Fault	<ol style="list-style-type: none"> <li>1. Circulating pump failed, or water system blocked</li> <li>2. Water flow switch failed, or opposite installed direction</li> <li>3. The lift of the circulating pump is not enough</li> <li>4. Circulating pump has opposite installed direction</li> </ol>
E04	Abnormal Communication Between The Main Control Board And Remote Module	Check the communication connection
E05	High-Voltage Switch One Fault	<ol style="list-style-type: none"> <li>1. High-voltage switch failed</li> <li>2. Excessive refrigerant</li> <li>3. Fan doesn't work typically, or water circulated abnormally</li> <li>4. Air or other objects mixed into the refrigeration system</li> <li>5. Too much scale in the water heat exchanger</li> </ol>
E06	Low-Voltage Switch One Fault	<ol style="list-style-type: none"> <li>1. Low-voltage switch fault</li> <li>2. Lack of refrigerant</li> <li>3. Fan doesn't work normally</li> <li>4. Block exists in refrigeration system</li> </ol>
E07	High-Voltage Switch Two Fault	Same as E05
E08	Low-Voltage Switch Two Fault	Same as E06
E10	Indoor Side Water Flow Failure	Same as E03
E11	Limited Time Protection	Enter the power-on password
E12	Exhaust Gas Temperature One Too High Fault	Lack of refrigerant in the fluorine circuit system or sensor damage
E13	Exhaust Gas Temperature Two Too High Fault	Lack of refrigerant in the fluorine circuit system or sensor damage
E14	Hot Water Tank Temperature Failure	Damaged motherboard or sensor
E15	Water Inlet Temperature Sensor Failure	Damaged motherboard or sensor
E16	Coil Sensor One Failure	Damaged motherboard or sensor
E17	Coil Sensor Two Failure	Damaged motherboard or sensor
E18	Exhaust Gas Sensor One Fault	Damaged motherboard or sensor
E19	Exhaust Gas Sensor Two Fault	Damaged motherboard or sensor
E20	Indoor Temperature Sensor Failure	Damaged motherboard or sensor
E21	Environmental Sensor Failure	Damaged motherboard or sensor
E22	User Return Water Sensor Failure	Damaged motherboard or sensor

E23	Cooling Subcooling Protection	Normal anti-freeze protection
E24	Board Change Out Temperature Fault	Damaged motherboard or sensor
E25	Water Level Switch Malfunction	Damage to the mainboard or water level sensor
E26	Anti-Freeze Sensor Malfunction	Damaged motherboard or sensor
E27	Water Outlet Sensor Failure	Damaged motherboard or sensor
E28	Reservation	Reservation
E29	Return Air Sensor One Fault	Damage to the mainboard or water level sensor
E30	Return Air Sensor Two Fault	Damage to the mainboard or water level sensor
E31	Water Pressure Switch Failure	Water pressure switch failure
E32	Excessive Water Temperature Protection	Insufficient water flow or a damaged sensor
E33	High Pressure One Sensor Fault	Damaged motherboard or sensor
E34	Low Pressure One Sensor Fault	Damaged motherboard or sensor
E35	Reservation	Reservation
E36	Reservation	Reservation
E37	The Excessive Temperature Difference Between Inlet And Outlet Water Protection	Insufficient water flow
E38	DC Fan One Failure	Fan drive board or motor damage
E39	DC Fan Two Failure	Fan drive board or motor damage
E40	DC Fan Three Failure	Fan drive board or motor damage
E41	DC Fan Four Failure	Fan drive board or motor damage
E42	Cooling Coil Sensor One Fault	Damaged motherboard or sensor
E43	Cooling Coil Sensor Two Fault	Damaged motherboard or sensor
E44	Low Ambient Temperature Protection	It is a standard protection
E45	High Voltage Two Sensor Failure	Damaged motherboard or sensor
E46	Low Voltage Two Sensor Failure	Damaged motherboard or sensor
E47	Economizer Inlet Sensor One Failure	Damaged motherboard or sensor
E48	Economizer Inlet Sensor Two Failure	Damaged motherboard or sensor
E49	Economizer Outlet Sensor One Failure	Damaged motherboard or sensor
E50	Economizer Outlet Sensor Two Failure	Damaged motherboard or sensor
E51	High Voltage One Overvoltage Protection	Same as E05
E52	Low Voltage One Undervoltage Protection	Same as E06
E53	High Voltage Two Overvoltage Protection	Same as E05
E54	High Voltage Two Undervoltage Protection	Same as E06
E55	Expansion Board Communication Exception	Poor or broken signal cable contact
E80	Power Supply Error	Single-phase power unit detects a three-phase electrical signal.
E88	Inverter Module 1 Protection	Compressor or compressor driver board damaged
E89	Inverter Module 2 Protection	Compressor or compressor driver



		board damaged
E94	Water Pump Feedback Failure	Damaged DC pump or poor signal line contact
E96	Abnormal Communication between Compressor One Driver and Main Control Board	Poor or broken signal cable contact
E97	Abnormal Communication between Compressor Two Driver and Main Control Board	Poor or broken signal cable contact
E98	Abnormal Communication between Fan Motor One Driver and Main Control Board	Poor or broken signal cable contact
E99	Abnormal Communication between Fan Motor Two Driver and Main Control Board	Poor or broken signal cable contact

## Fault Protection Instructions

1. The machine stops running when a fault is detected;
2. When the fault is removed, the compressor is shut down for three minutes before the machine can be put back into operation;
3. If there are three consecutive low-pressure faults, high-pressure fault, over the current spot, and gas exhaust temperature too high within 30 minutes, the machine will immediately stop running. After the fault is rectified, turn the power on again, start the controller, and the device can be put into operation.
4. If the machine stops running due to the inlet water temperature sensor or the coil temperature sensor fault due to compressor protection, the device will have to be back into operation 3mins later after the spot is removed. If the ambient temperature sensor fails, the machine continues to run.

## Maintenance Instructions

1. The machine is equipped with an inspection needle valve on the suction and exhaust pipes. The maintenance personnel can connect the pressure gauge to check the high and low-pressure conditions of the system.
2. If the machine is filled with refrigerant under operating conditions, the refrigerant must be served at the needle valve of the low-pressure side. Suppose the refrigerant is added to the suction side. In that case, the refrigerant opening must be small so that the refrigerant in the refrigerant bottle slowly enters the system to prevent liquid slamming.
3. Refrigerant leakage detection  
Check if there is any leakage at the joints with soapy water or a refrigerant leak detector. When a refrigerant leak occurs, the leak point must be found, and the leak point must be repaired. Please ensure no refrigerant or other pressures are left in the system when improving the leak point. Otherwise, it will easily cause copper pipe explosive during welding. The tube is blasted by refrigerant pressure or additional pressure, causing accidental injury to the operator. Note: When refrigerant leakage occurs in a small space, open all vents or forced ventilation to discharge the refrigerant before performing related operations to prevent people from suffocating accidents.

# Specification

Model			MMHP-008B1	MMHP-01281/B2	MMHP-01681/B2	MMHP-02081/B2	MMHP-026B2	
Power Supply			220-240V~/50Hz	220-240V~/50Hz; 380-415V~/3N/50Hz			380-415V~/3N/50Hz	
Heating 1	Capacity	KW	2.50-8.90	4.20-12.20	5.30-16.50	6.20-20.5	6.50-26.10	
	Input Power	KW	0.57-1.92	0.86-2.88	1.15-4.15	1.36-5.28	1.78-6.45	
	Input Current	A	2.53-8.52	3.82-12.77	5.10-18.41	2.31-8.96	2.87-10.35	
Heating 2	Capacity	KW	2.30-7.62	3.85-11.20	4.90-15.10	6.30-19.90	6.90-26.10	
	Input Power	KW	0.75-2.61	1.13-3.75	1.65-5.25	1.65-8.82	1.95-8.55	
	Input Current	A	3.32-11.58	5.01-16.60	7.32-23.30	2.80-11.58	3.15-13.80	
Cooling	Capacity	KW	1.80-7.10	2.60-10.30	4.50-13.50	5.50-17.50	5.20-21.30	
	Input Power	KW	0.61-2.43	0.91-3.65	1.45-4.85	1.65-6.25	1.95-8.20	
	Input Current	A	2.71-10.78	4.03-16.19	6.43-21.52	2.80-10.61	3.15-13.23	
SCOP (Water Temp. At 35°C)			4.92	4.55	4.58	4.67	4.85	
SCOP (Water Temp. At 55°C)			3.37	3.41	3.39	3.45	3.42	
EER (Water Temp. at 7 °C)			3.16	3.12	3.15	3.15	3.16	
Rated Input Power			KW	2.71	3.83	6.2	7.5	10
Rated Input Current			A	12	17	27.5	13	17
Refrigerant Type/Charge/GWP			-/kg	R32/1.25/675	R32/1.80/675	R32/2.8/675	R32/2.8/675	R32/3.5/675
CO <sub>2</sub> Equivalent			/	0.84t	1.21t	1.89t	2.36t	2.36t
Operation Pressure(Low Side)			MPa	1.5	1.5	1.5	1.5	1.5
Operation Pressure(High Side)			MPa	4.4	4.4	4.4	4.4	4.4
Maximum Allowable Pressure			MPa	4.4	4.4	4.4	4.4	4.4
Electrical Shockproof			/	I	I	I	I	I
IP Class			/	IPX4	IPX4	IPX4	IPX4	IPX4
Max. Outlet Water Temp.			°C	60	60	60	60	60
Operating Ambient Temperature			°C	-25 ~ 45	-25 ~ 45	-25 ~ 45	-25 ~ 45	-25 ~ 45
Water Piping Connections			inch	G1"	G1"	G1-1/4"	G1-1/2"	G1-1/2"
Rated Water Flow			m <sup>3</sup> /h	1.1	1.75	2.52	3.2	4.12
Water Pressure Drop			kPa	25	27	30	32	35
Min/Max water pressure			MPa	0.1/0.3	0.1/0.3	0.1/0.3	0.1/0.3	0.1/0.3
Noise Level			dB(A)	50	52	55	56	58
Net Dimensions (L×W×H)			mm	1000×445×850	1000×445×850	1110×480×850	1110×445×1450	1110×445×1450
Net Weight			kg	102	107	124	151	160

**Rated Test Conditions:**  
 Heating\* Ambient Temp 7°C/6°C(D8/W8);Water-In/Out Temp 30°C/35°C  
 Heating\* Ambient Temp 7°C/6°C(D8/W8);Water-In/Out Temp 47°C/55°C  
 Cooling\* Ambient Temp 35°C/24°C(D8/W8);Water-In/Out Temp 12°C/7°C

---

## After-sale Service

Relevant state regulations carry out the after-sales service of our products. Within the scope of the warranty period, If the machine is not working correctly under reasonable use, please contact the seller. The user must designate a person to manage and use the unit reasonably and correctly by our company's "Instructions for Use." Accidents caused by improper use are not covered by our company's warranty, and the repair costs and repair costs beyond the warranty period must be taken care of by the user.

### 1. After-sale Service

The seller or the specified professional installer should perform maintenance and repair. Improper maintenance or repair may result in water leakage, electric shock, and fire.

- 1.1 Please contact the seller when the machine has to be moved or reinstalled. Improper installation may result in water leakage, electric shock, and fire.
- 1.2 When you need after-sales service, please contact the seller and provide the following details:
  - 1) Model No.
  - 2) Serial Number and Manufacture Date
  - 3) Detailed Description of the fault
  - 4) Your name, Address, and Contact Number

If the warranty period is expired or the malfunction is caused by improper use, the company will charge a certain service fee if you need after-sales service.

### 2. Maintenance

After a period of use, the heat pump's performance will be reduced due to the accumulation of dust inside the machine, so maintenance is required.

- 1) You should regularly check the water supply system to avoid the air entering the water system and the occurrence of low water flow, which would reduce the performance and reliability of the heat pump.
- 2) Clean your filtration system regularly to avoid unit damage because of a dirty or clogged filter.
- 3) Discharge the water from the bottom of the water pump if the heat pump will stop running for a long time (especially in winter)
- 4) At any other moment, check the water flow to confirm enough water before the unit starts to run again.
- 5) After the unit is conditioned in winter, it is preferred to cover the team with a unique winter heat pump cover.