

Operation Manual of Solar Controller SR1568 for Split Solar System

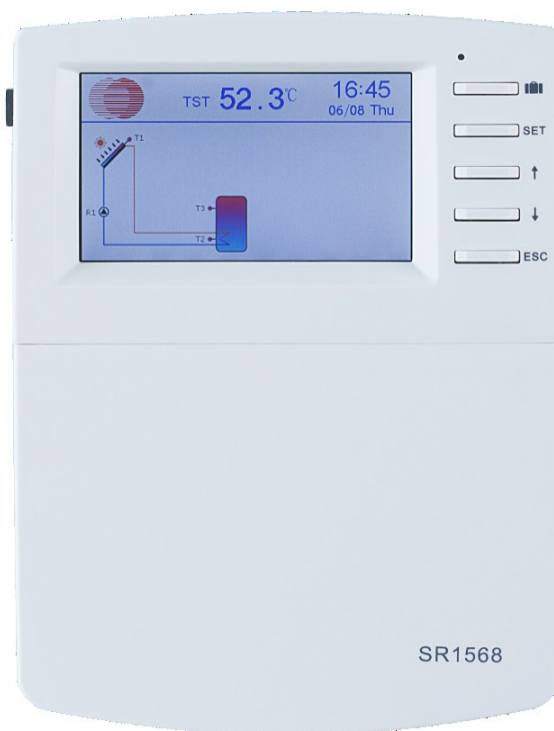

Read the instruction carefully please before operation!

Contens

1 Safety information4
1.1 Installation and commissioning4
1.2 About this manual.....4
1.3 Liability waiver4
1.4 Important information4
1.5 Signal description5
1.6 HMI button.....5
2 Overview6
2.1 Controller introduction6
2.2 Delivery list.....6
2.3 Technical data6
3 Installation7
3.1 Mounting controller.....7
3.2 Wiring connection.....8
3.3 Terminal connection8
3.4 TF (MicroSD) Card 11
4. System12
4.1 Overview of the available systems12
4.2 Description of 23 systems13
System 1: Standard solar system with 1 tank, 1 collector field.....14
System 2: Solar system with 1 tank, 1 collector field, 3-ways valve for tank loading in layers15
System 3: Solar system with 1 tank, east/west collector fields16
System 4: Solar system with east/west collector fields, 3-ways valve for tank loading in layers17
System 5: Solar system with east/west collector fields, 1 tank, valve-logic control18
System 6: Solar system with 1 collector field, 1 tank, loading the heating return19
System 7: Solar system with 1 collector field, 1 tank, 3-ways valve loading tank in layers, loading the heating return20
System 8: Solar system with east/west collector field, 1 tank, loading the heating return21
System 9: Solar system with east/west collector fields, 1 tank, 3-ways valve switch collector, loading the heating return.....22
System 10: Solar system with east/west collector fields, 1 tank, 3-ways valve loading tank in layers, loading the heating return.....23
System 11: Solar system with1 collector field, 2 tanks, 3-ways valve switch loading tank24
System 12: Solar system with 1 collector field, 2 tanks, Pump switch loading tank25
System 13: Solar system with east/west collector fields, 2 tanks, 3-ways valve switch loading tank26

System 14: Solar system with 1 collector field, 2 tanks, thermal energy transferring between 2 tanks	27
System 15: Solar system with 1 collector field, 2 tanks, valve switch loading tank, thermal energy transferring between 2 tanks	28
System 16: Solar system with 1 collector field, 2 tanks, valve switch loading tank in layers, thermal energy transferring between 2 tanks	29
System 17: Solar system with 1 collector field, 2 tanks, pump switch loading tank, thermal energy transferring between 2 tanks	30
System 18: Solar system with east/west collector fields, 2 tanks, valve logic control to load in layers, energy transferring between 2 tanks	31
System 19: Solar system with east/west collector fields, 2 tanks, thermal energy transferring between 2 tanks	32
System 20: Solar system with east/west collector fields, 2 tanks, valve switch loading tank, thermal energy transferring between 2 tanks	33
System 21: Solar system with 1 collector field, 2 tanks, valve switch loading tank, preheating return of heating system	34
System 22: Solar system with 1 collector field, 2 tanks, pump switch loading tank, preheating return of heating system	35
System 23: Solar system with east/west collector fields, 2 tanks, valve switch loading tank, preheating return of heating system	36
4.3 Commissioning	37
5 Functions and options	37
5.1 Overview of menu structure	37
5.2 Menu operation description	38
5.3 Check value	38
5.4 Menu function	38
(1) Date (Time/ Date setup)	38
(2) Light (Screen lightness adjust)	39
(3) Timed Heat (Timing heating)	40
(4) Circle (DHW circulation pump control function)	42
(5) Password	45
(6) SYS (System selection)	45
(7) LOAD / (8) LOAD2 (Tank 1/Tank 2 heating setup)	46
(9) COL Collector 1 function / (10) COL2 Collector 2 function	48
(11) PNMP Pump control	51
(12) LLOGI Tank Priority	53
(13) COOL Cooling function	55

Operation manual of solar controller SR1568

(14) HEATX Heat exchange between tanks	58
(15) RPH Return preheating.....	59
(16) AUX Auxiliary functions	60
(17) MAN Manual function.....	63
(18) BLPR Pump blocking protection	64
(19) OTDIS Thermal disinfection function	65
(20) OPARR Parallel relay.....	66
(21) OHQM Heat quantity measurement.....	66
(22) FS Flow meter type selection.....	69
(23) PRESS Pressure monitoring.....	70
(24) UNIT C- F Temperature unit switch	71
(25) OSDC SD card.....	71
(26) RESET Reset.....	74
(27) PASS Password set.....	74
6 Holiday function.....	75
7 Software of controller upgrade	75
8 Protection function.....	78
8.1 Screen protection	78
8.2 Trouble protection.....	78
8.3 Trouble checking	78
9 Quality Guarantee	84
10 Accessories	85

1 Safety information

1.1 Installation and commissioning

- When laying wires, please ensure that no damage occurs to any of the constructional fire safety measures presented in the building.
- The controller must not be installed in rooms where easily inflammable gas mixtures are present or may occur.
- The permissible environmental conditions can't be exceeded at the site of installation.
- Before connecting the device, make sure that the energy supply matches the specifications that controller requires.
- All devices connected to the controller must conform to the technical specifications of the controller.
- All operations on an open controller are only to be conducted cleared from the power supply. All safety regulations for working on the power supply are valid.
- Connecting and /or all operations that require opening the collector (e.g. changing the fuse) are only conducted by specialists.

1.2 About this manual

This manual describes the installation, functions and operation of a solar controller. When installing the remaining components of the solar system e.g. the solar collectors and the tank unit, please be sure to observe the appropriate installation instructions provided by each manufacturer. Installation, electrical connection, commissioning and maintenance of the device may only be performed by qualified professional person. The professional person must be familiar with this manual and follow the instructions contained herein.

1.3 Liability waiver

The manufacturer can't monitor the compliance with these instructions or the circumstances and methods used for installation, operation, utilization and maintenance of this controller. Improper installation can cause damages to material and person. This is the reason why we do not take over responsibility and liability for losses, damages or cost that might arise due to improper installation, operation or wrong utilization and maintenance or that occurs in some connection with the aforementioned. Moreover, we do not take over liability for patent infringements or infringements – occurring in connection with the use of this controller on the third parties' rights. The manufacturer preserves the right to put changes to product, technical data or installation and operation instructions without prior notice. As soon as it becomes evident that safe operation is no longer possible (e.g. visible damage). Please immediate take the device out of operation.



Note: ensure that the device can't be accidentally placed into operation.

1.4 Important information

We have carefully checked the text and pictures of this manual and provided the best of

our knowledge and ideas; however inevitable errors maybe exist. Please note that we cannot guarantee that this manual is given in the integrity of image and text, they are just some examples, and they apply only to our own system. Incorrect, incomplete and erroneous information and the resulting damage we do not take responsibility.

1.5 Signal description



Safety indication: Safety instructions in the text are marked with a warning triangle. They indicate measures which can lead to injury of person or safety risks.

Operation steps: small triangle “▶” is used to indicate operation step.



Notes: Contains important information about operation or functions.

1.6 HMI button

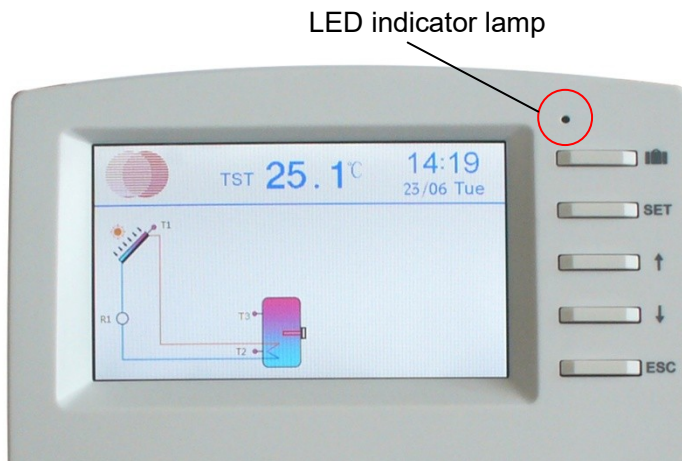

➤ Controller is operated with the 5 buttons besides the screen

- “” holiday button
- “SET” button: confirm / selection
- “↑” up button: increase the value
- “↓” down button: reduce the value
- “ESC” button return/ exit: return to previous menu



Note: TST is temperature of tank (on the screen)

2 Overview

2.1 Controller introduction

- TFT colorful screen display
- 7 * relay outputs
- 9 * sensor inputs
- 1 * Grundfos Direct Sensor TM (VFS) analog input
- 1 * Grundfos Direct Sensor TM (RPS) analog input
- 1 * (FRT) Vane type flow meter input
- 3 * Variable frequency PWM outputs for the speed control of pump
- Data saved on the TF card (Micro SD)
- 485 communication port for communication module
- 23 systems for choose

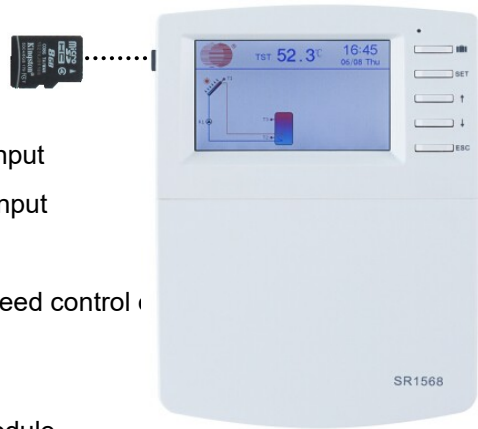

2.2 Delivery list

- 1 * SR1568 controller
- 1 * accessory bag
- 1 * user manual
- 2 * screw and expansion
- 2 * PT1000 temperature sensor ($\phi 6 \times 50$ mm, cable length 1.5meter)
- 5 * NTC10K temperature sensor ($\phi 6 \times 50$ mm, cable length 3meter)
- 1 * clamp bag

2.3 Technical data

- Input:
 - 2* PT1000 temperature sensors
 - 7* NTC10K, B=3950 temperature sensors
 - 1* Grundfos Direct Sensor TM (VFS type) analog input
 - 1* Grundfos Direct Sensor TM (RPS type) analog input
 - 1* (FRT) Vane type flow meter input
- Output:
 - 4* Electromagnetic relay, Max. current 1A
 - 3* Semiconductor repay, Max. current 1A
 - 3* PWM variable frequency output (switchable 0-10V)
- Functions:

operating hours counter, tube collector function, thermostat function, pump speed control, heat quantity measurement, external heat exchange, adjustable system parameters and optional functions (menu-driven), balance and diagnostics

- Power supply: 100...240V ~ (50...60Hz)
- Rated impulse voltage: 2.5KV
- Data interface: TF (Micro SD)
- 485 current supply: 60mA
- Housing: Plastic ABS
- Mounting: Wall mounting
- Indication / Display:
System-Monitoring-Display, for visualization of the systems, TFT colorful display and background illumination
- Operation: 5 push buttons at the front cover
- Protection type: IP41
- Protection class: I
- Ambient temperature: 0 ... 40 °C
- Dimensions: 208*158*43mm



Note: TF (Micro SD) isn't included in the delivery list

3 Installation



Note: This controller must only be located in the dry interior rooms. Please separate routing of sensor wires and mains wires. Make sure the controller as well as the system is not exposed to strong electromagnetic fields.

3.1 Mounting controller

Follow the below steps to mount the controller on the wall.

- Unscrew the crosshead screw from the cover and remove it along with the cover from the housing.
- Mark the upper fastening point on the wall. Drill and fasten the enclosed wall plug and screw leaving the head protruding.
- Hang the housing from the upper fastening point and mark the lower fastening points (centers 180 mm).
- Drill and insert lower wall plugs.
- Fasten the housing to the wall with the lower fastening



screw and tighten.

- Carry out the electrical wiring in accordance with the terminal allocation
- Put the cover on the housing. Attach with the fastening screw.

3.2 Wiring connection

According to the way of installation, wire can be connected from hole A on the bottom plate or from hole B, using a suitable tool (like knife) to cut the plastic of A.

Note: wires must be fastened by fixing clamps on position C.

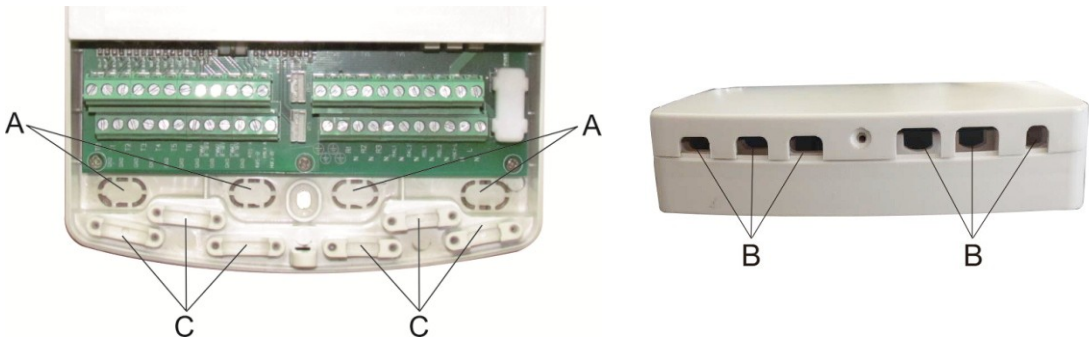

3.3 Terminal connection



Note: before opening the housing! Always disconnect the controller from power supply and obey the local electrical supply regulation.

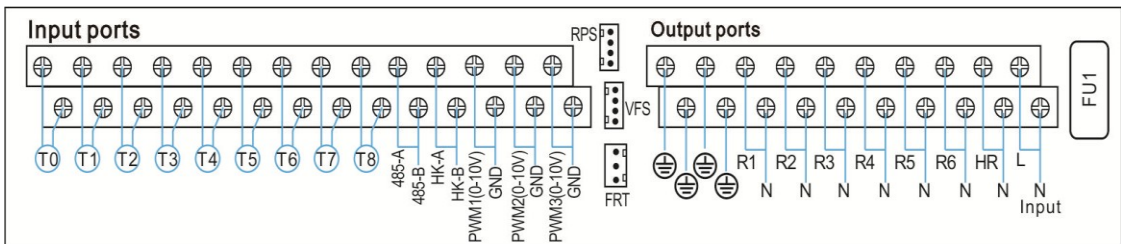

- **Input ports**

- T0~T1: PT1000 temperature sensor, for measuring the temperature of collector
- T2~T8: NTC10K, B=3950 temperature sensor, for measuring temperature of storage and pipe.
- 485 Communication port: ELA485, for remote control communication module, A/B must be wired correctly.
- PWM1, PWM2, PWM3: Signal ports for high efficiency pump, detailed connection see below
- RPS: For Grundfos pressure sensor
- VFS: For Grundfos flowmeter sensor

- FRT: For Vane type flow meter

- **Advice regarding the installation of temperature sensors:**

- 1) Only original factory equipped Pt1000 temperature sensors are approved for using with the collector, it is equipped with 1.5m silicon cable and suitable for all weather conditions, the cable is temperature resistant up to 280°C, connect the temperature sensors to the corresponding terminals with either polarity.
- 2) Only original factory equipped NTC10K, B=3950 temperature sensors are approved for using with tank and pipe, it is equipped with 3m PVC cable, and the cable is temperature resistant up to 105°C, connect the temperature sensors to the corresponding terminals with either polarity.
- 3) All sensor cables carry low voltage, and to avoid inductive effects, must not be laid close to 230 volt or 400-volt cables (minimum separation of 100mm).
- 4) If external inductive effects are existed, e.g. from heavy current cables, overhead train cables, transformer substations, radio and television devices, amateur radio stations, microwave devices etc., then the cables to the sensors must be adequately shielded.
- 5) Sensor cables may be extended to a maximum length of ca. 100 meters, when cable's length is up to 50m, and then 0.75mm² cable should be used. When cable's length is up to 100m, and then 1.5mm² cables should be used.

- **Output ports**

- Input Ports L N: for power connection, L: live wire, N: zero wire,  earth wire
- Output R1: Semiconductor relays (SCR), designed for pump speed control, Max. Current: 1A
- Output R2: Semiconductor relays (SCR), designed for pump speed control, Max. Current: 1A
- Output R3: Semiconductor relays (SCR), designed for pump speed control, Max. Current: 1A
- Output R4: Electromagnetic relays, designed for on/off control of pump or 3-ways electromagnetic valve, Max. Current: 1A
- Output R5: Electromagnetic relays, designed for on/off control of pump or 3-ways electromagnetic valve, Max. Current: 1A
- Output R6: Electromagnetic relays, designed for on/off control of pump or 3-ways electromagnetic valve, Max. Current: 1A
- Output HR: Electromagnetic relays, designed for on/off control of back-up heating device, Max. Current: 1A

- R4, R5, R6 terminals for 3-ways valve / pump connection

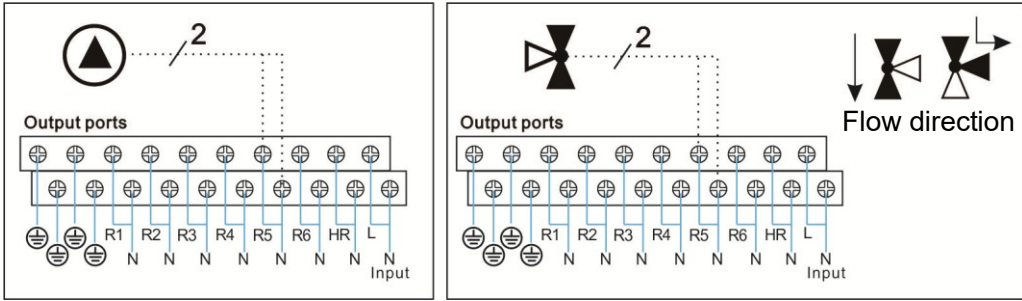

Controller output ports: select 3-ways valve with 2 wires

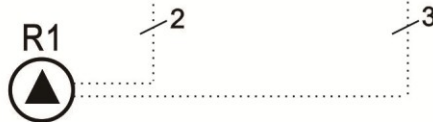
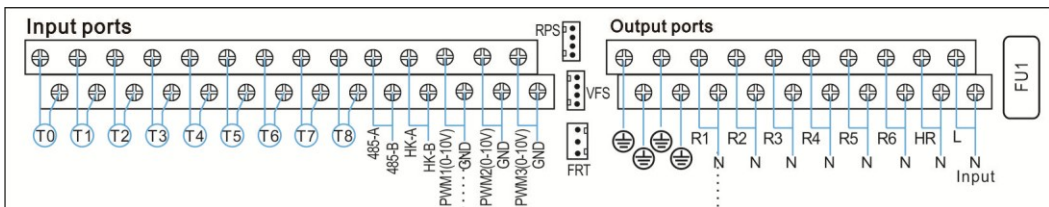

- Connecting the signal wire from the high-efficiency pump

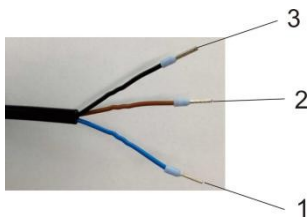

Signal	Overmoulded Pin	Cable color
PWM input (from controller)	1	Grey or blue
PWM common	2	brown
PWM output (from the pump)	3	black

- Signal wire 1 from the high-efficiency pump is connected to GND port of controller
- Signal wire 2 from the high-efficiency pump is connected to PWM1 port of controller
- Signal wire 3 from the high-efficiency pump is not connected to the controller
- Some pumps connections are available as above, for example:
 Wilo Yonos PARA ST15/7.0 PWM2 M
 Grundfos UPM3 SOLAR 15-75 130 CZA

i Note:

- 1) High-efficiency pump with 0-10V signal only has 2 signal wires, connected to the corresponding port GND, PWM1 of controller.
- 2) Blue wire not always represent for “GND” and brown wire not always represent for “PWM”.

- 3) "PWM" from pump must be connected on the "PWM" port of controller.
"GND" from pump must be connected on the "GND" port of controller

3.4 TF (MicroSD) Card

Controller is equipped with a slot for TF (Micro SD) card. With TF (MicroSD) card, following functions can be carried out:

- Save the measured data in the MicroSD card. After transferring the data to a computer, data can be opened and visualized, e. g. in a spreadsheet.
- Save the set of adjustment and parameters on the MicroSD card, and if necessary, retrieve them from there.
- Copy the updated firmware software from PC and install them on the controller via MicroSD card.

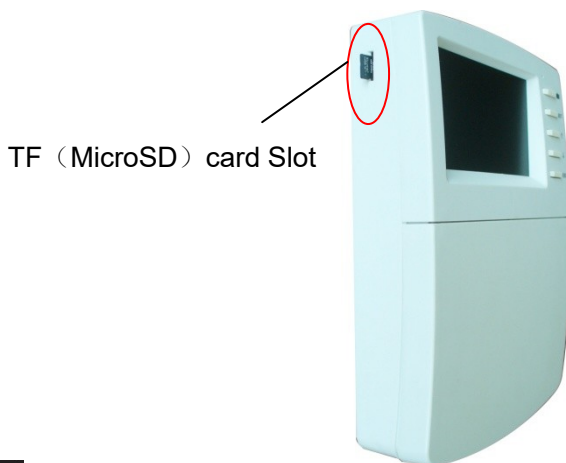

i **Note:** TF (MicroSD) card is not listed in the standard delivery package, self-purchase if need, more detailed about TF (MicroSD) see paragraph 5.3.1

4. System

4.1 Overview of the available systems

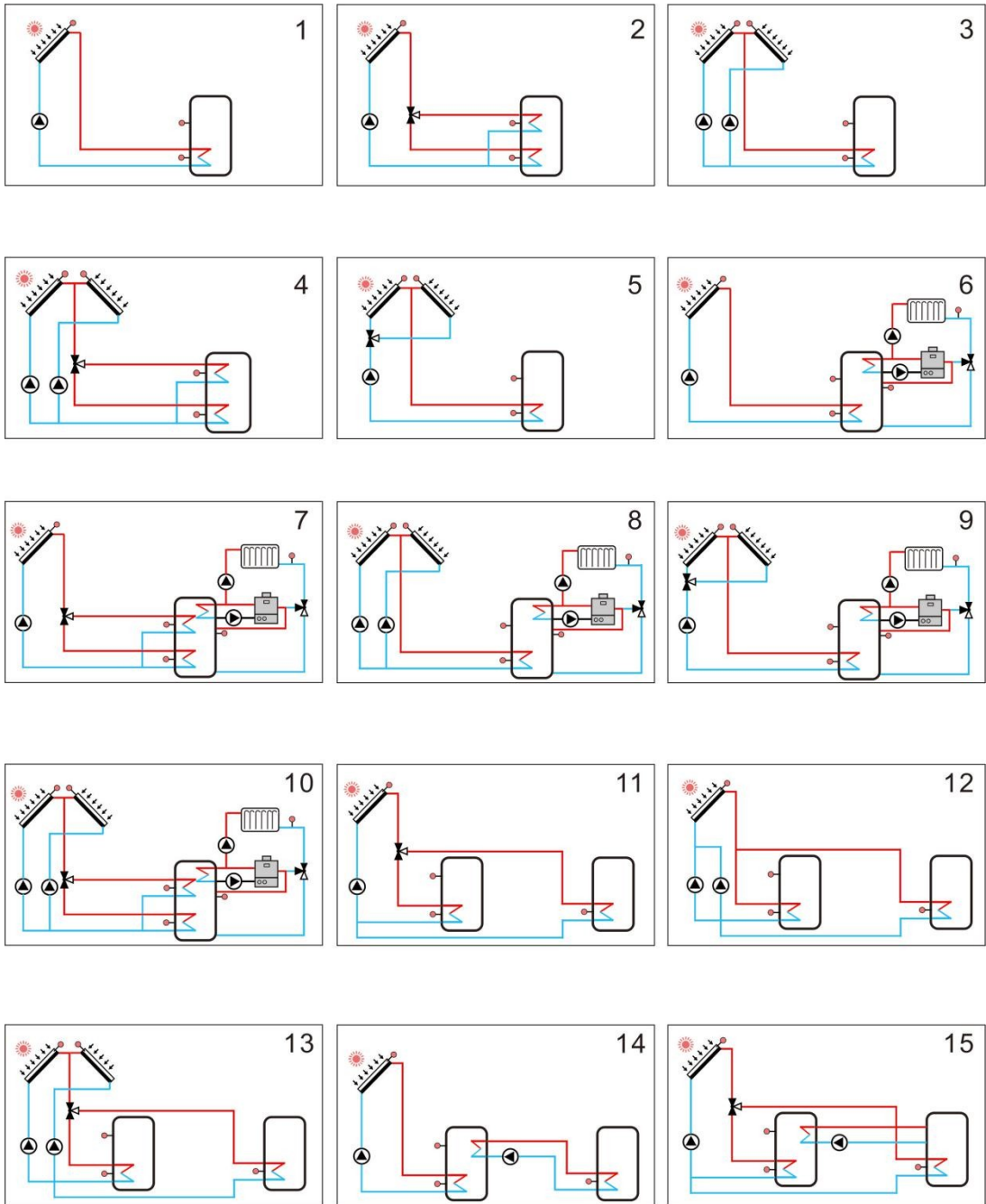

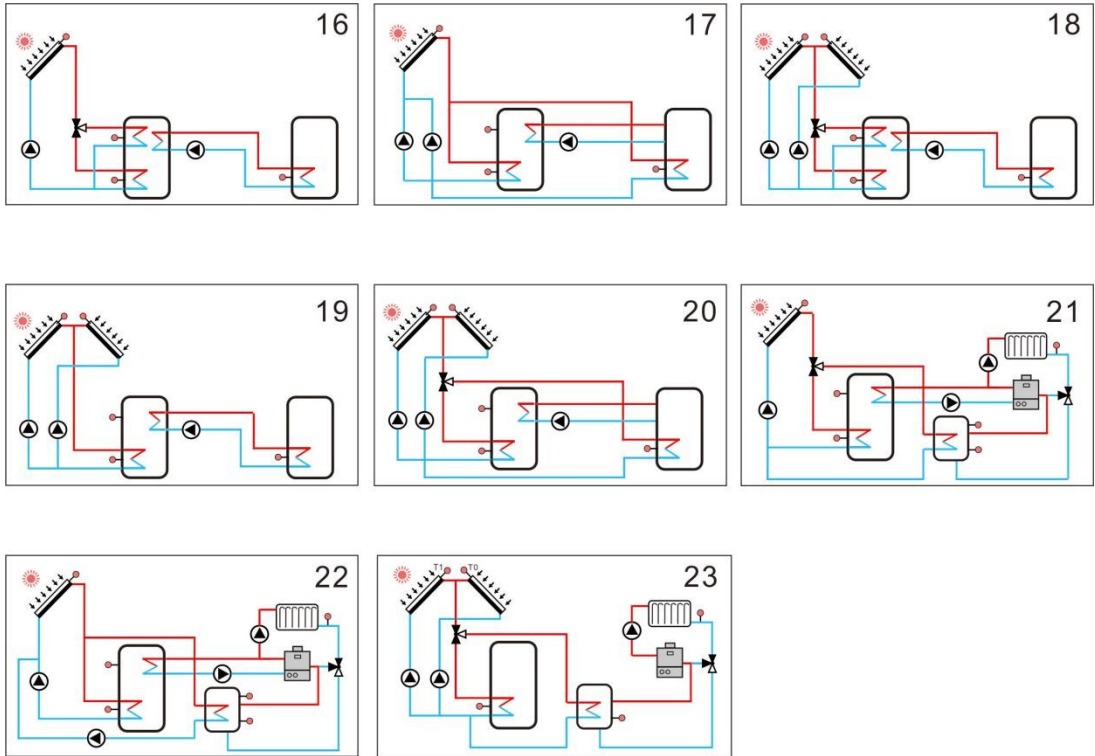

4.2 Description of 23 systems

Note: Auxiliary functions introduction!

The system diagrams showed in this manual are used for normal solar hot water system design, for individual application, some very useful auxiliary functions are available in this controller, it makes the controller more intelligent and user friendly.

We provide these auxiliary functions “CIRC, OHDP, SFB, BYPR, TIMER, AH, OPARR” in every system diagram, there are undefined sensor input ports and output relays (it means free output in the selected system), customer can define these sensors and outputs according to individual specified system, if the corresponding input or output is defined, it is no longer available for other functions.

Auxiliary functions should be activated firstly under the relevant menu.

System 1: Standard solar system with 1 tank, 1 collector field

Description:

The controller calculates the temperature difference between collector sensor T1 and tank sensor T2. If the difference is larger than or identical to the adjusted switch-on temperature difference (DTO), the solar circulation pump (R1) will be switched on and keep running to heat tank until the switch-off temperature difference (DTF) or the maximum tank temperature (SMX) is reached.

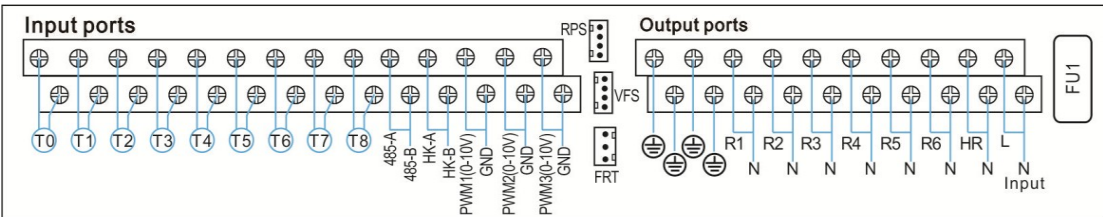
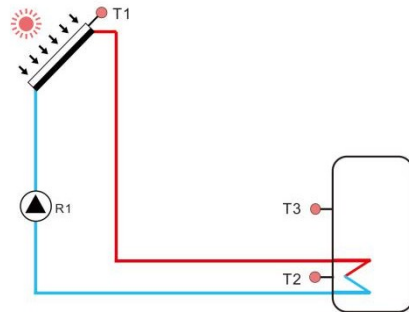

Sensor Input	Description	Relay output	Description
T0	Selectable sensor, undefined	R1	Solar circulation pump
T1	Temperature sensor of collector	R2	Available optional auxiliary functions: 1.CIRC (DHW circulation pump) 2.OHDP (Thermal transfer function) 3.SFB (Solid fuel boiler function) 4.BYPR (Circulation by-pass) 5.TIMER (Timer function) 6.AH (Automatic thermostat) 7.OPARR (Parallel relay)
T2	Temperature sensor of tank base	R3	
T3	Temperature sensor of tank upper (optional)	R4	
T4	Selectable sensor, undefined	R5	
T5	Selectable sensor, undefined	R6	
T6	Temperature sensor for thermal energy measurement (optional)	HR	Back-up heating
T7	Selectable sensor, undefined		
T8	Selectable sensor, undefined		

System 2: Solar system with 1 tank, 1 collector field, 3-ways valve for tank loading in layers

Description:

The controller calculates the temperature difference between collector sensor T1 and tank sensor T2 and T3. If the difference is larger than or identical to the adjusted switch-on temperature difference (DTO/DT2O), the solar circulation pump (R1) will be switched on, and simultaneously motor valve R4 will turn to the corresponding tank zone, that part of tank will be loaded until the switch-off temperature difference(DTF/DT2F) or the maximum tank temperature (SMX/S2MX) is reached. Priority heating logic will ensure to heat the upper part of tank firstly.

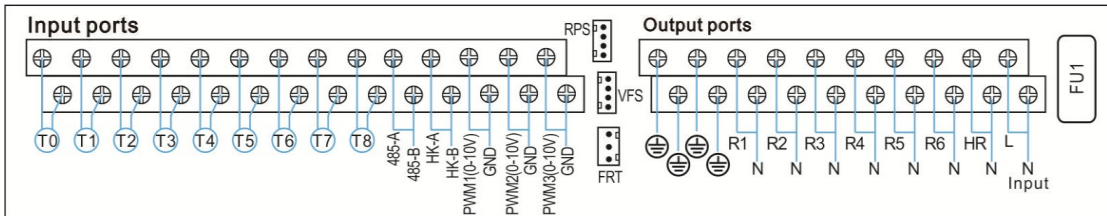
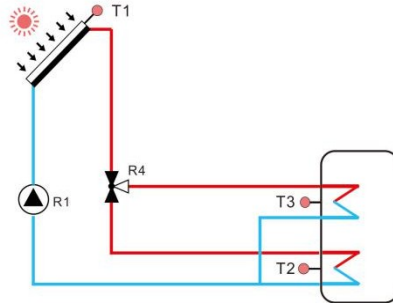

Sensor Input	Description	Relay output	Description
T0	Selectable sensor, undefined	R1	Solar circulation pump
T1	Temperature sensor of collector	R4	3-ways valve for loading in layers
T2	Temperature sensor of tank base	R2	Available optional auxiliary functions: 1.CIRC (DHW circulation pump) 2.OHDP (Thermal transfer function) 3.SFB (Solid fuel boiler function) 4.BYPR (Circulation by-pass) 5.TIMER (Timer function) 6.AH (Automatic thermostat) 7.OPARR (Parallel relay)
T3	Temperature sensor of tank upper	R3	
T4	Selectable sensor, undefined	R5	
T5	Selectable sensor, undefined	R6	
T6	Temperature sensor for thermal energy measurement (optional)		
T7	Selectable sensor, undefined		
T8	Selectable sensor, undefined	HR	Back-up heating

System 3: Solar system with 1 tank, east/west collector fields

Description:

The controller calculates the temperature difference between collector sensor T1, T0 and tank sensor T2. If one of the differences is larger than or identical to the adjusted switch-on temperature difference (DTO), then the corresponding solar circulation pump (R1 and /or R2) will be switched on, tank will be loaded until the switch-off temperature difference (DTF) or the maximum tank temperature (SMX) is reached.

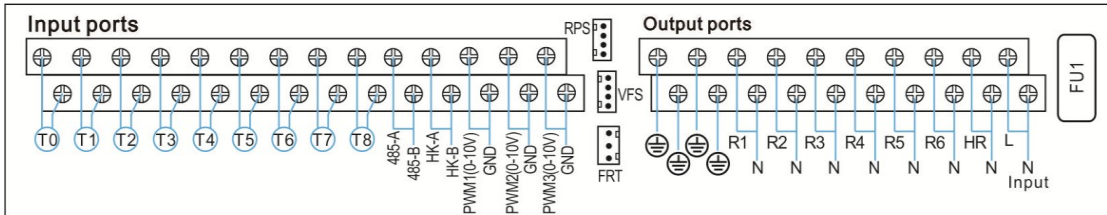
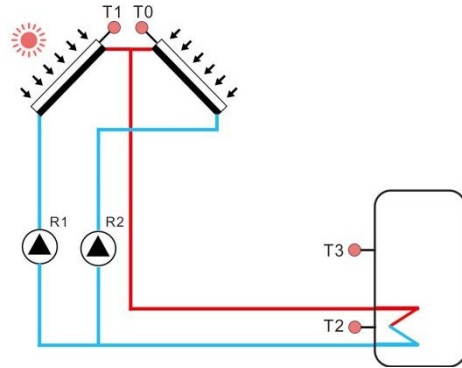

Sensor Input	Description	Relay output	Description
T0	Temperature sensor of collector 2	R1	Solar circulation pump 1
T1	Temperature sensor of collector 1	R2	Solar circulation pump 2
T2	Temperature sensor of tank base	R3	Available optional auxiliary functions: 1.CIRC (DHW circulation pump) 2.OHDP (Thermal transfer function) 3.SFB (Solid fuel boiler function) 4.BYPR (Circulation by-pass) 5.TIMER (Timer function) 6.AH (Automatic thermostat) 7.OPARR (Parallel relay)
T3	Temperature sensor of tank upper (optional)	R4	
T4	Selectable sensor, undefined	R5	
T5	Selectable sensor, undefined	R6	
T6	Temperature sensor for thermal energy measurement (optional)		
T7	Selectable sensor, undefined		
T8	Selectable sensor, undefined		
		HR	Back-up heating

System 4: Solar system with east/west collector fields, 3-ways valve for tank loading in layers

Description:

The controller calculates the temperature difference between collector sensor T1, T0 and tank sensor T2, T3. If one of the differences is larger than or identical to the adjusted switch-on temperature difference (DTO/DT2O), then the corresponding solar circulation pump (R1 and /or R2) will be switched on, and simultaneously motor valve R4 will turn to the corresponding tank zone, that part of tank will be loaded until the switch-off temperature difference(DTF/DT2F) or the maximum tank temperature (SMX/S2MX) is reached. Priority heating logic will ensure to heat the upper part of tank firstly.

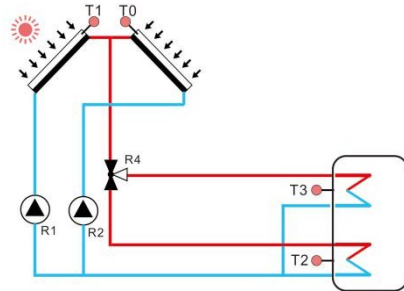

Input ports

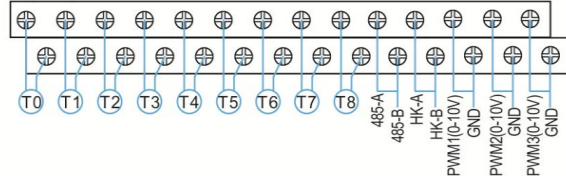

Output ports

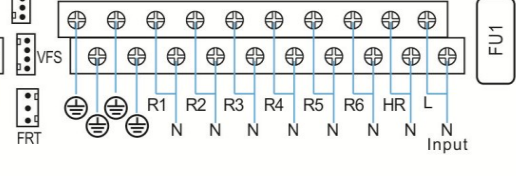

Sensor Input	Description	Relay output	Description
T0	Temperature sensor of collector 2	R1	Solar circulation pump 1
T1	Temperature sensor of collector 1	R2	Solar circulation pump 1
T2	Temperature sensor of tank base	R4	3-ways valve for loading in layers
T3	Temperature sensor of tank upper	R3	Available optional auxiliary functions: 1.CIRC (DHW circulation pump) 2.OHDP (Thermal transfer function) 3.SFB (Solid fuel boiler function) 4.BYPR (Circulation by-pass) 5.TIMER (Timer function) 6.AH (Automatic thermostat) 7.OPARR (Parallel relay)
T4	Selectable sensor, undefined	R5	
T5	Selectable sensor, undefined	R6	
T6	Temperature sensor for thermal energy measurement (optional)		
T7	Selectable sensor, undefined		
T8	Selectable sensor, undefined	HR	Back-up heating

System 5: Solar system with east/west collector fields, 1 tank, valve-logic control

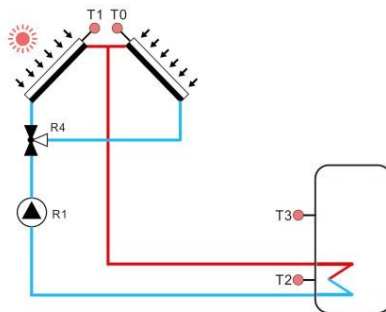
<p>Description:</p> <p>The controller calculates the temperature difference between collector sensor T1, T0 and tank sensor T2. If one of the differences is larger than or identical to the adjusted switch-on temperature difference (DTO), then the corresponding solar circulation pump (R1) will be switched on, and simultaneously motor valve R4 will turn to the corresponding collector, tank will be loaded until the switch-off temperature difference(DTF) or the maximum tank temperature (SMX) is reached.</p>	
---	--

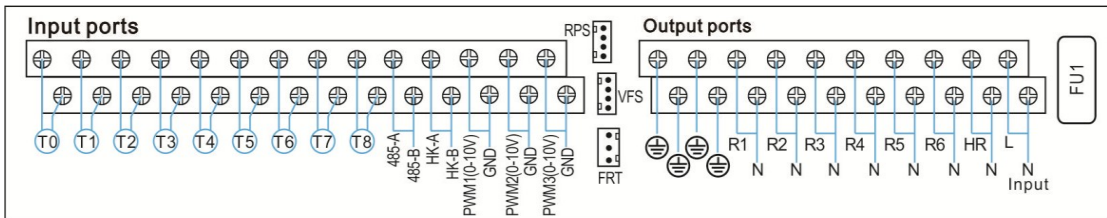

Sensor Input	Description	Relay output	Description
T0	Temperature sensor of collector 2	R1	Solar circulation pump
T1	Temperature sensor of collector 1	R4	3-ways valve for collector
T2	Temperature sensor of tank base	R2	Available optional auxiliary functions: 1.CIRC (DHW circulation pump) 2.OHDP (Thermal transfer function) 3.SFB (Solid fuel boiler function) 4.BYPR (Circulation by-pass) 5.TIMER (Timer function) 6.AH (Automatic thermostat) 7.OPARR (Parallel relay)
T3	Temperature sensor of tank upper (optional)	R3	
T4	Selectable sensor, undefined	R5	
T5	Selectable sensor, undefined	R6	
T6	Temperature sensor for thermal energy measurement (optional)		
T7	Selectable sensor, undefined		
T8	Selectable sensor, undefined	HR	Back-up heating

System 6: Solar system with 1 collector field, 1 tank, loading the heating return

<p>Description:</p> <p>The controller calculates the temperature difference between collector sensor T1 and tank sensor T2. If the difference is larger than or identical to the adjusted switch-on temperature difference (DTO), then the corresponding solar circulation pump (R1) will be switched on, tank will be loaded until the switch-off temperature difference (DTF) or the maximum tank temperature (SMX) is reached.</p> <p>Another temperature difference function between T4 and T5 is used to control the 3-ways valve R4 to pre-heat the heating return (see paragraph 5.4.15)</p>	
--	--

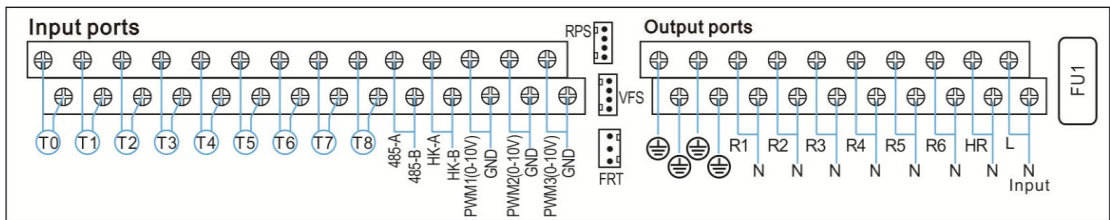

Sensor Input	Description	Relay output	Description
T0	Selectable sensor, undefined	R1	Solar circulation pump
T1	Temperature sensor of collector	R4	3-ways valve for pre-heat the heating return
T2	Temperature sensor of tank base	Available optional auxiliary functions: 1.CIRC (DHW circulation pump) 2.OHDP (Thermal transfer function) 3.SFB (Solid fuel boiler function) 4.BYPR (Circulation by-pass) 5.TIMER (Timer function) 6.AH (Automatic thermostat) 7.OPARR (Parallel relay)	R2
T3	Temperature sensor of tank upper (optional)		R3
T4	Temperature sensor for pre-heat the heating return (optional)		R5
T5	Temperature sensor of heating return		R6
T6	Temperature sensor for thermal energy measurement (optional)		
T7	Selectable sensor, undefined		
T8	Selectable sensor, undefined	HR	Back-up heating

System 7: Solar system with 1 collector field, 1 tank, 3-ways valve loading tank in layers, loading the heating return

Description:
 The controller calculates the temperature difference between collector sensor T1 and tank sensor T2 and T3. If one of the differences is larger than or identical to the adjusted switch-on temperature difference (DTO/DT2O), then the corresponding solar circulation pump (R1) will be switched on, and simultaneously valve R4 turns to the corresponding tank zone, that part of tank will be loaded until the switch-off temperature difference (DTF/DT2F) or the maximum tank temperature (SMX/S2MX) is reached. Priority heating logic will ensure to heat the upper part of tank firstly.

Another temperature difference function between T4 and T5 is used to control the 3-ways valve R5 to pre-heat the heating return (see paragraph 5.4.15)

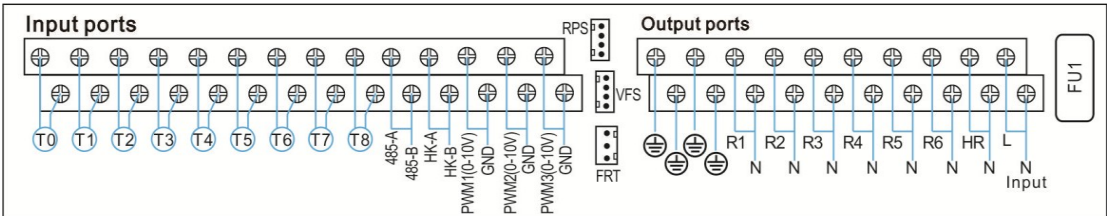
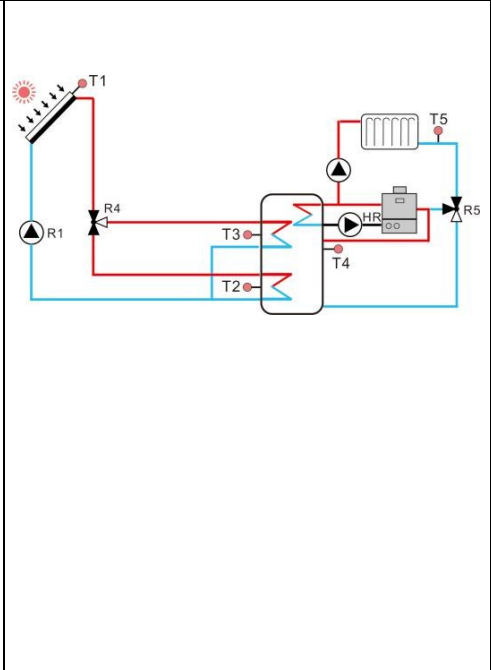

Sensor Input	Description	Relay output	Description
T0	Selectable sensor, undefined	R1	Solar circulation pump
T1	Temperature sensor of collector	R4	3-ways valve for load tank in layers
T2	Temperature sensor of tank base	R5	3-ways valve for pre-heat the heating return
T3	Temperature sensor of tank upper	R2	Available optional auxiliary functions: 1.CIRC (DHW circulation pump) 2.OHDP (Thermal transfer function) 3.SFB (Solid fuel boiler function) 4.BYPR (Circulation by-pass) 5.TIMER (Timer function) 6.AH (Automatic thermostat) 7.OPARR (Parallel relay)
T4	Temperature sensor for pre-heat the heating return (optional)	R3	
T5	Temperature sensor of heating return	R6	
T6	Temperature sensor for thermal energy measurement (optional)		
T7	Selectable sensor, undefined		
T8	Selectable sensor, undefined	HR	Back-up heating

System 8: Solar system with east/west collector field, 1 tank, loading the heating return

<p>Description: The controller calculates the temperature difference between collector sensor T1, T0 and tank sensor T2. If one of the differences is larger than or identical to the adjusted switch-on temperature difference (DTO), then the corresponding solar circulation pump (R1 and /or R2) will be switched on, tank will be loaded until the switch-off temperature difference (DTF) or the maximum tank temperature (SMX) is reached.</p> <p>Another temperature difference function between T4 and T5 is used to control the 3-ways valve R4 to pre-heat the heating return (see paragraph 5.4.15)</p>	
---	--

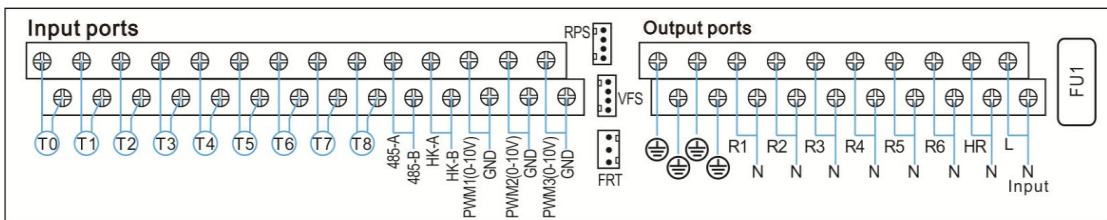

Sensor Input	Description	Relay output	Description
T0	Temperature sensor of collector 2	R1	Solar circulation pump 1
T1	Temperature sensor of collector 1	R2	Solar circulation pump 2
T2	Temperature sensor of tank base	R4	3-ways valve for pre-heat the heating return
T3	Temperature sensor of tank upper (optional)	R3	Available optional auxiliary functions: 1.CIRC (DHW circulation pump) 2.OHDP (Thermal transfer function) 3.SFB (Solid fuel boiler function) 4.BYPR (Circulation by-pass) 5.TIMER (Timer function) 6.AH (Automatic thermostat) 7.OPARR (Parallel relay)
T4	Temperature sensor for pre-heat the heating return (optional)	R5	
T5	Temperature sensor of heating return	R6	
T6	Temperature sensor for thermal energy measurement (optional)		
T7	Selectable sensor, undefined		
T8	Selectable sensor, undefined		
		HR	Back-up heating

System 9: Solar system with east/west collector fields, 1 tank, 3-ways valve switch collector, loading the heating return

Description:

The controller calculates the temperature difference between collector sensor T1, T0 and tank sensor T2. If one of the differences is larger than or identical to the adjusted switch-on temperature difference (DTO), then solar circulation pump (R1) will be switched on, and simultaneously valve R4 turns to the corresponding collector, tank will be loaded until the switch-off temperature difference (DTF) or the maximum tank temperature (SMX) is reached.

Another temperature difference function between T4 and T5 is used to control the 3-ways valve R5 to pre-heat the heating return (see paragraph 5.4.15)

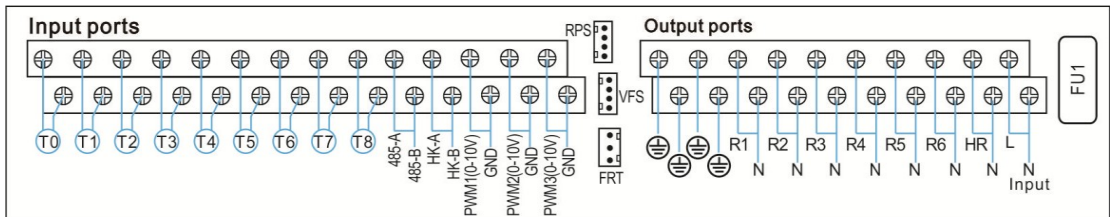
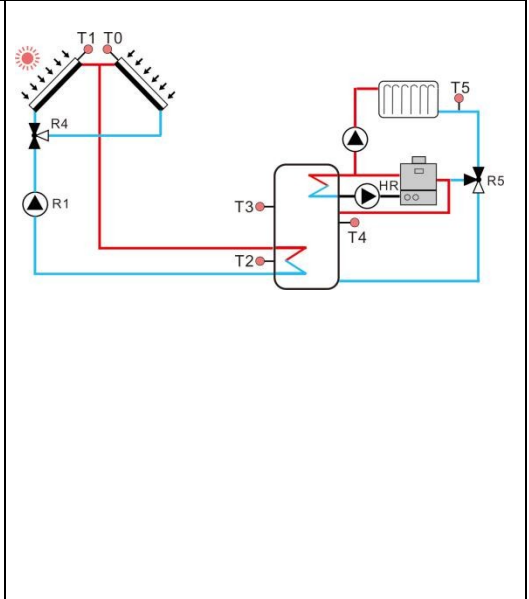

Sensor Input	Description	Relay output	Description
T0	Temperature sensor of collector 2	R1	Solar circulation pump
T1	Temperature sensor of collector 1	R4	3-ways valve for collector
T2	Temperature sensor of tank base	R5	3-ways valve for pre-heat the heating return
T3	Temperature sensor of tank upper (optional)	R2	Available optional auxiliary functions: 1.CIRC (DHW circulation pump) 2.OHDP (Thermal transfer function) 3.SFB (Solid fuel boiler function) 4.BYPR (Circulation by-pass) 5.TIMER (Timer function) 6.AH (Automatic thermostat) 7.OPARR (Parallel relay)
T4	Temperature sensor for pre-heat the heating return (optional)	R3	
T5	Temperature sensor of heating return	R6	
T6	Temperature sensor for thermal energy measurement (optional)		
T7	Selectable sensor, undefined		
T8	Selectable sensor, undefined		
		HR	

System 10: Solar system with east/west collector fields, 1 tank, 3-ways valve loading tank in layers, loading the heating return

Description:

The controller calculates the temperature difference between collector sensor T1, T0 and tank sensor T2. If one of the differences is larger than or identical to the adjusted switch-on temperature difference (DTO/DT2) then solar circulation pump (R1 and/or R2) will be switched on, and simultaneously valve R4 turns to the corresponding collector, tank will be loaded until the switch-off temperature difference (DTF/DT2F) or the maximum tank temperature (SMX/S2MX) is reached. Priority heating logic will ensure to heat the upper part of tank firstly.

Another temperature difference function between T4 and T5 is used to control the 3-ways valve R5 to pre-heat the heating return (see paragraph 5.4.15)

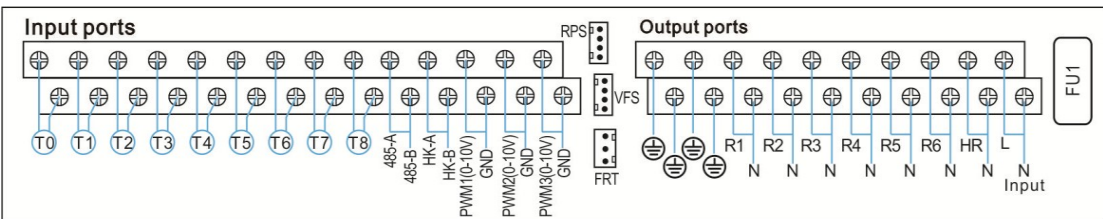
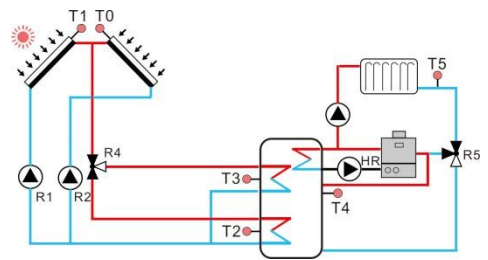

Sensor Input	Description	Relay output	Description
T0	Temperature sensor of collector 2	R1	Solar circulation pump 1
T1	Temperature sensor of collector 1	R2	Solar circulation pump 2
T2	Temperature sensor of tank base	R4	3-ways valve for tank loading in layers
T3	Temperature sensor of tank upper	R5	3-ways valve for pre-heat the heating return
T4	Temperature sensor for pre-heat the heating return (optional)	R3	Available optional auxiliary functions: 1.CIRC (DHW circulation pump) 2.OHDP (Thermal transfer function) 3.SFB (Solid fuel boiler function) 4.BYPR (Circulation by-pass) 5.TIMER (Timer function) 6.AH (Automatic thermostat) 7.OPARR (Parallel relay)
T5	Temperature sensor of heating return	R6	
T6	Temperature sensor for thermal energy measurement (optional)		
T7	Selectable sensor, undefined		
T8	Selectable sensor, undefined	HR	Back-up heating

System 11: Solar system with 1 collector field, 2 tanks, 3-ways valve switch loading tank

Description:

The controller calculates the temperature difference between collector sensor T1 and tank sensor T2, T4. If the differences is larger than or identical to the adjusted switch-on temperature difference (DTO/DT2O), then solar circulation pump (R1) will be switched on, and simultaneously valve R4 turns to the corresponding tank, tank will be loaded until the switch-off temperature difference (DTF/DT2F) or the maximum tank temperature (SMX/S2MX) is reached. Priority heating logic will ensure to heat tank 1 firstly.

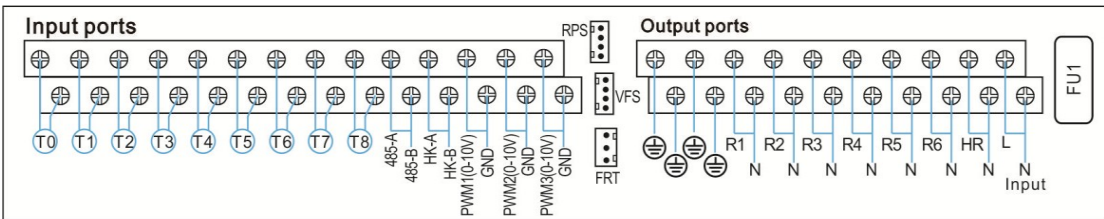
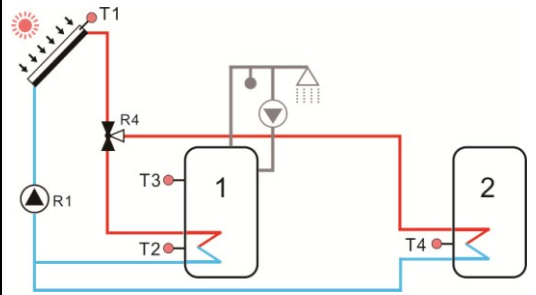

Sensor Input	Description	Relay output	Description
T0	Selectable sensor, undefined	R1	Solar circulation pump 1
T1	Temperature sensor of collector	R4	3-ways valve for tank loading
T2	Temperature sensor of tank 1 base	Available optional auxiliary functions: 1.CIRC (DHW circulation pump) 2.OHDP (Thermal transfer function) 3.SFB (Solid fuel boiler function) 4.BYPR (Circulation by-pass) 5.TIMER (Timer function) 6.AH (Automatic thermostat) 7.OPARR (Parallel relay)	R2
T3	Temperature sensor of tank 1 upper (optional)		R3
T4	Temperature sensor of tank 2 base		R5
T5	Selectable sensor, undefined		R6
T6	Temperature sensor for thermal energy measurement (optional)		
T7	Selectable sensor, undefined		
T8	Selectable sensor, undefined		
		HR	Back-up heating

System 12: Solar system with 1 collector field, 2 tanks, Pump switch loading tank

Description:
 The controller calculates the temperature difference between collector sensor T1 and tank sensor T2, T4. If the differences are larger than or identical to the adjusted switch-on temperature difference (DTO/DT2O), then corresponding solar circulation pump (R1 / R2) will be switched on, tank will be loaded until the switch-off temperature difference (DTF/DT2F) or the maximum tank temperature (SMX/S2MX) is reached.

Priority heating logic will ensure to heat tank 1 firstly.

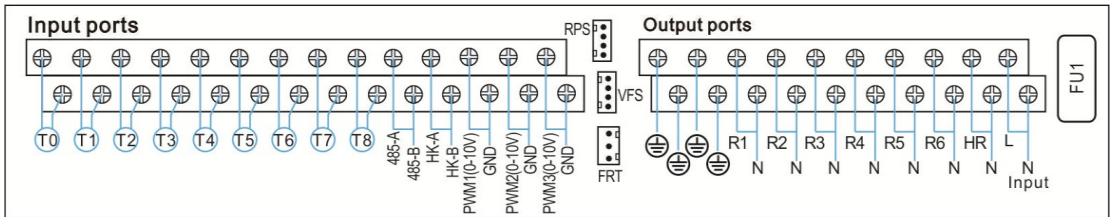

Sensor Input	Description	Relay output	Description
T0	Selectable sensor, undefined	R1	Solar circulation pump 1
T1	Temperature sensor of collector	R2	Solar circulation pump 2
T2	Temperature sensor of tank 1 base	R3	Available optional auxiliary functions: 1.CIRC (DHW circulation pump) 2.OHDP (Thermal transfer function) 3.SFB (Solid fuel boiler function) 4.BYPR (Circulation by-pass) 5.TIMER (Timer function) 6.AH (Automatic thermostat) 7.OPARR (Parallel relay)
T3	Temperature sensor of tank upper (optional)	R4	
T4	Temperature sensor of tank 2 base	R5	
T5	Selectable sensor, undefined	R6	
T6	Temperature sensor for thermal energy measurement (optional)		
T7	Selectable sensor, undefined		
T8	Selectable sensor, undefined	HR	Back-up heating

System 13: Solar system with east/west collector fields, 2 tanks, 3-ways valve switch loading tank

Description:

The controller calculates the temperature difference between collector sensor T1,T0 and tank sensor T2,T4. If the differences is larger than or identical to the adjusted switch-on temperature difference (DTO/DT2O), then corresponding solar circulation pump (R1 and/ or R2) will be switched on, and simultaneously valve R4 turns to the corresponding tank, tank will be loaded until the switch-off temperature difference (DTF/DT2F) or the maximum tank temperature (SMX/S2MX) is reached.

Priority heating logic will ensure to heat tank 1 firstly.

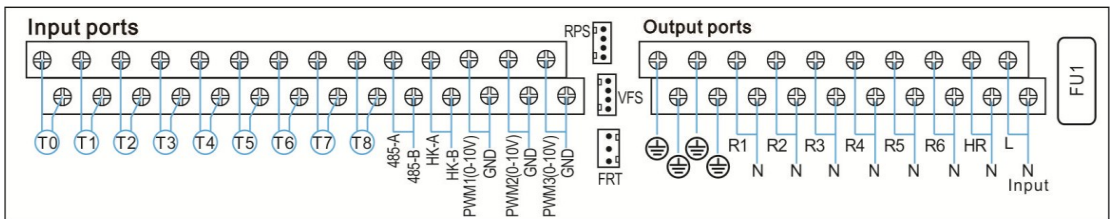
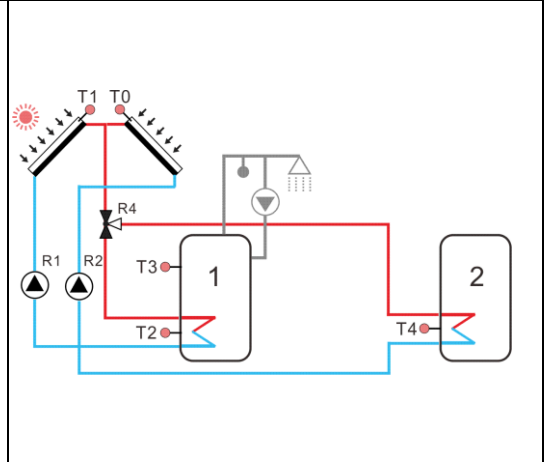

Sensor Input	Description	Relay output	Description
T0	Temperature sensor of collector 2	R1	Solar circulation pump 1
T1	Temperature sensor of collector 1	R2	Solar circulation pump 2
T2	Temperature sensor of tank 1 base	R4	3-ways valve for tank loading
T3	Temperature sensor of tank upper (optional)	R3	Available optional auxiliary functions: 1.CIRC (DHW circulation pump)
T4	Temperature sensor of tank 2 base	R5	2.OHDP (Thermal transfer function)
T5	Selectable sensor, undefined	R6	3.SFB (Solid fuel boiler function)
T6	Temperature sensor for thermal energy measurement (optional)		4.BYPR (Circulation by-pass)
T7	Selectable sensor, undefined		5.TIMER (Timer function)
T8	Selectable sensor, undefined		6.AH (Automatic thermostat)
		HR	7.OPARR (Parallel relay)
			Back-up heating

System 14: Solar system with 1 collector field, 2 tanks, thermal energy transferring between 2 tanks

Description:

The controller calculates the temperature difference between collector sensor T1 and tank sensor T2. If the difference is larger than or identical to the adjusted switch-on temperature difference (DTO), then solar circulation pump (R1) will be switched on, tank will be loaded until the switch-off temperature difference (DTF) or the maximum tank temperature (SMX) is reached.

Thermal energy transferring between 2 tanks means one tank will heat the other one. Another temperature difference between T3 and T4 will control pump R2. (see paragraph 5.4.14)

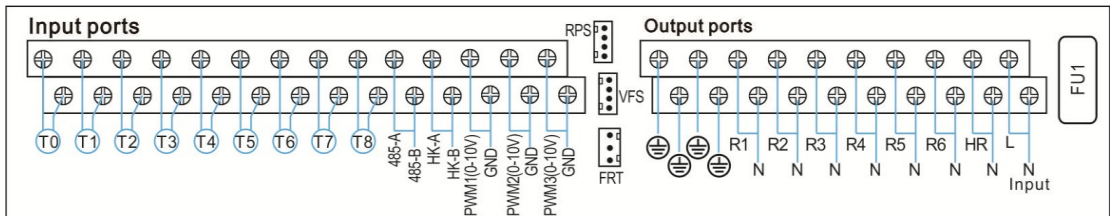
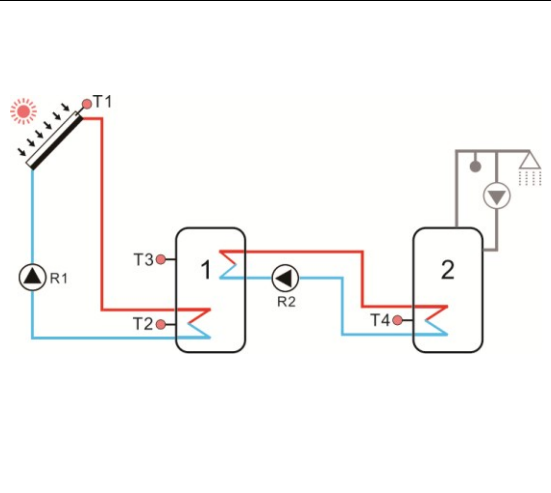

Sensor Input	Description	Relay output	Description
T0	Selectable sensor, undefined	R1	Solar circulation pump 1
T1	Temperature sensor of collector	R2	Circulation pump for energy transferring
T2	Temperature sensor of tank 1 base	R3	Available optional auxiliary functions: 1.CIRC (DHW circulation pump) 2.OHDP (Thermal transfer function) 3.BYPR (Circulation by-pass) 4.TIMER (Timer function) 5.AH (Automatic thermostat) 6.OPARR (Parallel relay)
T3	Temperature sensor of tank upper (optional)	R4	
T4	Temperature sensor of tank 2 base	R5	
T5	Selectable sensor, undefined	R6	
T6	Temperature sensor for thermal energy measurement (optional)		
T7	Selectable sensor, undefined		
T8	Selectable sensor, undefined	HR	Back-up heating

System 15: Solar system with 1 collector field, 2 tanks, valve switch loading tank, thermal energy transferring between 2 tanks

Description:

The controller calculates the temperature difference between collector sensor T1 and tank sensor T2,T4. If the differences is larger than or identical to the adjusted switch-on temperature difference (DTO/DT2O), then solar circulation pump (R1) will be switched on, and simultaneously valve R4 turns to the corresponding tank, tank will be loaded until the switch-off temperature difference (DTF/DT2F) or the maximum tank temperature (SMX/S2MX) is reached.

Priority heating logic will ensure to heat tank 1 firstly.

Thermal energy transferring between 2 tanks means one tank will heat the other one. Another temperature difference between T3 and T4 will control pump R2. (see paragraph 5.4.14)

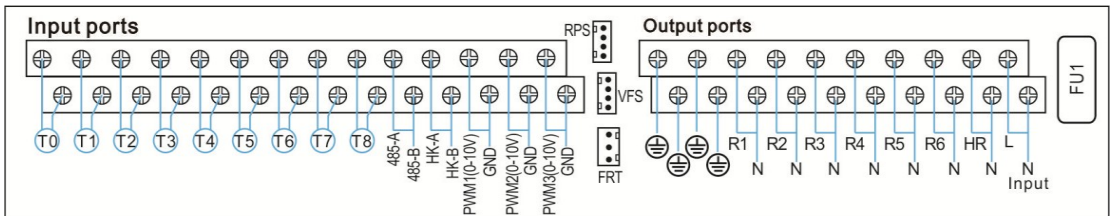
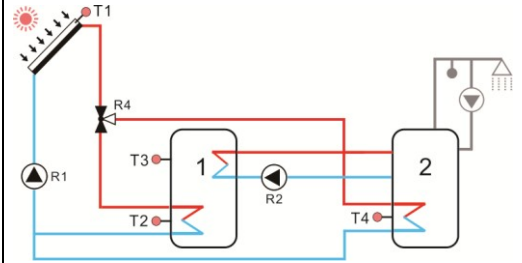

Sensor Input	Description	Relay output	Description
T0	Selectable sensor, undefined	R1	Solar circulation pump 1
T1	Temperature sensor of collector	R2	Circulation pump for energy transferring
T2	Temperature sensor of tank 1 base	R4	3-ways valve for switch tank
T3	Temperature sensor of tank upper (optional)	R3	Available optional auxiliary functions: 1. CIRC (DHW circulation pump) 2. OHDP (Thermal transfer function) 3. BYPR (Circulation by-pass) 4. TIMER (Timer function) 5. AH (Automatic thermostat) 6. OPARR (Parallel relay)
T4	Temperature sensor of tank 2 base	R5	
T5	Selectable sensor, undefined	R6	
T6	Temperature sensor for thermal energy measurement (optional)		
T7	Selectable sensor, undefined		
T8	Selectable sensor, undefined		
		HR	Back-up heating

System 16: Solar system with 1 collector field, 2 tanks, valve switch loading tank in layers, thermal energy transferring between 2 tanks

Description:

The controller calculates the temperature difference between collector sensor T1 and tank sensor T2,T3. If the differences is larger than or identical to the adjusted switch-on temperature difference (DTO/DT2O), then solar circulation pump (R1) will be switched on, and simultaneously valve R4 turns to the corresponding tank, tank will be loaded until the switch-off temperature difference (DTF/DT2F) or the maximum tank temperature (SMX/S2MX) is reached. Priority heating logic will ensure to heat the upper part of tank firstly.

Thermal energy transferring between 2 tanks means one tank will heat the other one. Another temperature difference between T3 and T4 will control pump R2. (see paragraph 5.4.14)

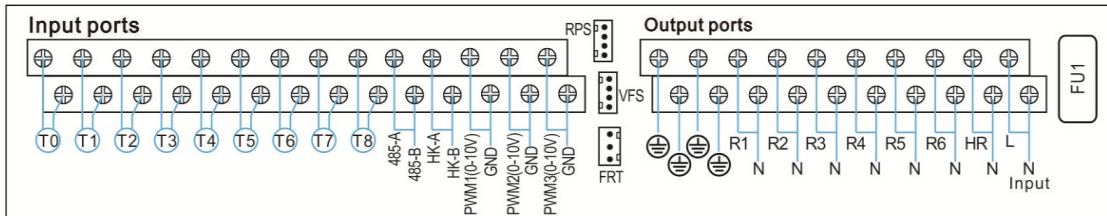
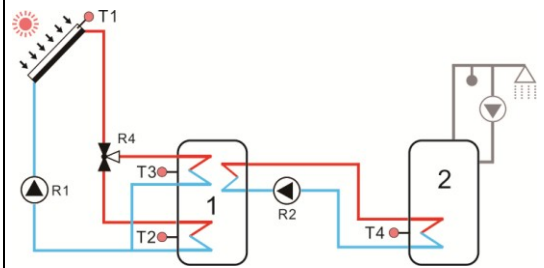

Sensor Input	Description	Relay output	Description
T0	Selectable sensor, undefined	R1	Solar circulation pump
T1	Temperature sensor of collector	R2	Circulation pump for energy transferring
T2	Temperature sensor of tank 1 base	R4	3-ways valve for switch tank
T3	Temperature sensor of tank upper (optional)	R3	Available optional auxiliary functions: 1. CIRC (DHW circulation pump) 2. OHDP (Thermal transfer function) 3. BYPR (Circulation by-pass) 4. TIMER (Timer function) 5. AH (Automatic thermostat) 6. OPARR (Parallel relay)
T4	Temperature sensor of tank 2 base	R5	
T5	Selectable sensor, undefined	R6	
T6	Temperature sensor for thermal energy measurement (optional)		
T7	Selectable sensor, undefined		
T8	Selectable sensor, undefined		
		HR	Back-up heating

System 17: Solar system with 1 collector field, 2 tanks, pump switch loading tank, thermal energy transferring between 2 tanks

Description:

The controller calculates the temperature difference between collector sensor T1 and tank 1/2 sensor T2,T4. If the differences are larger than or identical to the adjusted switch-on temperature difference (DTO/DT2O), then solar circulation pump (R1 and /or R2) will be switched on, the corresponding tank will be loaded until the switch-off temperature difference (DTF/DT2F) or the maximum tank temperature (SMX/S2MX) is reached.

Priority heating logic will ensure to heat tank 1 firstly.

Thermal energy transferring between 2 tanks means one tank will heat the other one. Another temperature difference between T3 and T4 will control pump R3. (see paragraph 5.4.14)

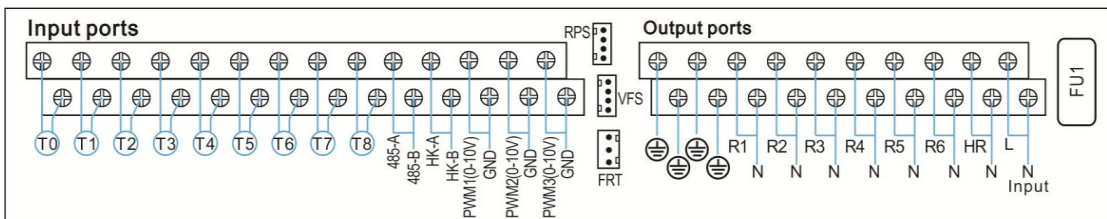
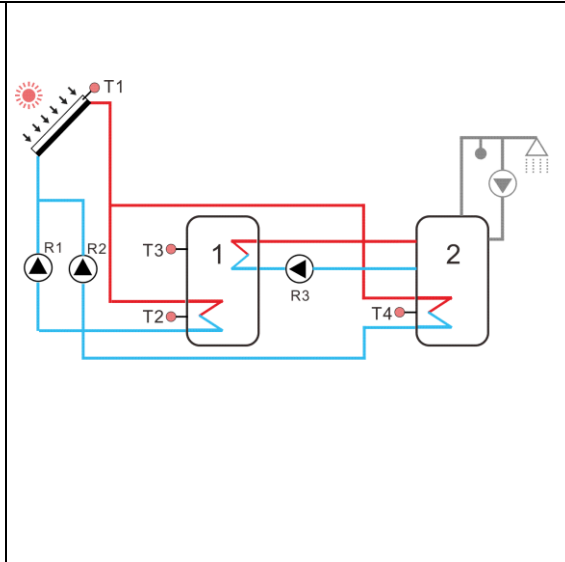

Sensor Input	Description	Relay output	Description
T0	Selectable sensor, undefined	R1	Solar circulation pump 1
T1	Temperature sensor of collector	R2	Solar circulation pump 2
T2	Temperature sensor of tank 1 base	R3	Circulation pump for energy transferring
T3	Temperature sensor of tank upper (optional)	R4	Available optional auxiliary functions: 1. CIRC (DHW circulation pump) 2. OHDP (Thermal transfer function) 3. BYPR (Circulation by-pass) 4. TIMER (Timer function) 5. AH (Automatic thermostat) 6. OPARR (Parallel relay)
T4	Temperature sensor of tank 2 base	R5	
T5	Selectable sensor, undefined	R6	
T6	Temperature sensor for thermal energy measurement (optional)		
T7	Selectable sensor, undefined		
T8	Selectable sensor, undefined		
		HR	Back-up heating

System 18: Solar system with east/west collector fields, 2 tanks, valve logic control to load in layers, energy transferring between 2 tanks

Description:

The controller calculates the temperature difference between collector sensor T1 and T0 and tank sensor T2 and T3. If one of the differences is larger than or identical to the adjusted switch-on temperature difference (DTO/DT2O), then solar circulation pump (R1 and /or R2) will be switched on, and simultaneously valve R4 turns to the corresponding tank zone, that part of tank will be loaded until the switch-off temperature difference (DTF/DT2F) or the maximum tank temperature (SMX/S2MX) is reached.

Priority heating logic will ensure to heat the upper part of tank firstly.

Thermal energy transferring between 2 tanks means one tank will heat the other one. Another temperature difference between T3 and T4 will control pump R3. (see paragraph 5.4.14)

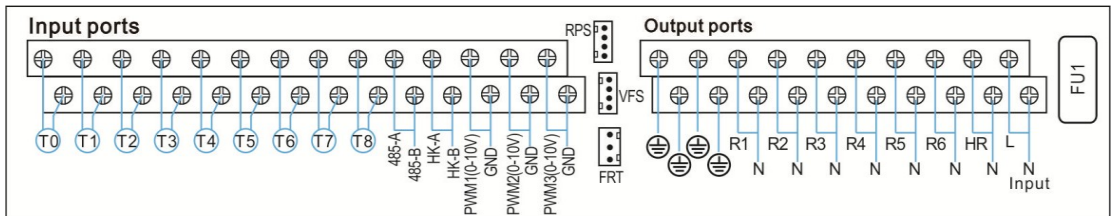
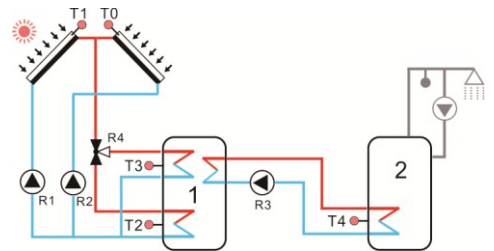

Sensor Input	Description	Relay output	Description
T0	Temperature sensor of collector 2	R1	Solar circulation pump 1
T1	Temperature sensor of collector 1	R2	Solar circulation pump 2
T2	Temperature sensor of tank 1 base	R3	Circulation pump for energy transferring
T3	Temperature sensor of tank 1 upper (optional)	R4	3-ways valve for switch tank
T4	Temperature sensor of tank 2 base	R5	Available optional auxiliary functions: 1. CIRC (DHW circulation pump) 2. OHDP (Thermal transfer function) 3. BYPR (Circulation by-pass) 4. TIMER (Timer function) 5. AH (Automatic thermostat) 6. OPARR (Parallel relay)
T5	Selectable sensor, undefined	R6	
T6	Temperature sensor for thermal energy measurement (optional)		
T7	Selectable sensor, undefined		
T8	Selectable sensor, undefined		
		HR	

System 19: Solar system with east/west collector fields, 2 tanks, thermal energy transferring between 2 tanks

Description:

The controller calculates the temperature difference between collector sensor T1 and T0 and tank sensor T2. If the differences are larger than or identical to the adjusted switch-on temperature difference (DTO), then solar circulation pump (R1 and /or R2) will be switched on, tank will be loaded until the switch-off temperature difference (DTF) or the maximum tank temperature (SMX) is reached.

Thermal energy transferring between 2 tanks means one tank will heat the other one. Another temperature difference between T3 and T4 will control pump R3. (see paragraph 5.4.14)

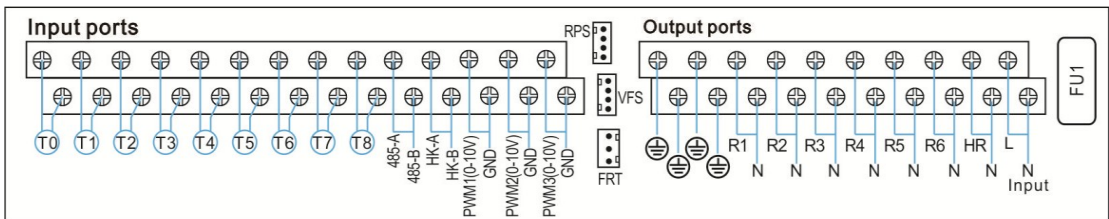
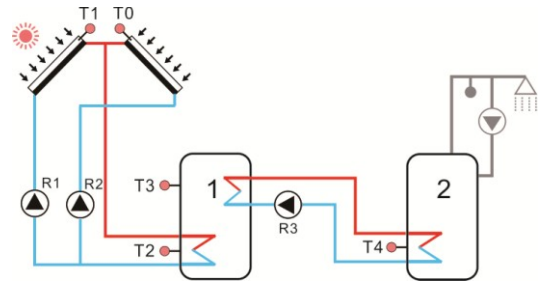

Sensor Input	Description	Relay output	Description
T0	Temperature sensor of collector 2	R1	Solar circulation pump 1
T1	Temperature sensor of collector 1	R2	Solar circulation pump 2
T2	Temperature sensor of tank 1 base	R3	Circulation pump for energy transferring
T3	Temperature sensor of tank 1 upper (optional)	R4	Available optional auxiliary functions: 1. CIRC (DHW circulation pump) 2. OHDP (Thermal transfer function) 3. BYPR (Circulation by-pass) 4. TIMER (Timer function) 5. AH (Automatic thermostat) 6. OPARR (Parallel relay)
T4	Temperature sensor of tank 2 base	R5	
T5	Selectable sensor, undefined	R6	
T6	Temperature sensor for thermal energy measurement (optional)		
T7	Selectable sensor, undefined		
T8	Selectable sensor, undefined		
		HR	Back-up heating

System 20: Solar system with east/west collector fields, 2 tanks, valve switch loading tank, thermal energy transferring between 2 tanks

Description:

The controller calculates the temperature difference between collector sensor T1 and T0 and tank sensor T2 and T4. If the differences is larger than or identical to the adjusted switch-on temperature difference (DTO/DT2O), then solar circulation pump (R1 and /or R2) will be switched on, and simultaneously valve R4 turns to the corresponding tank, that tank will be loaded until the switch-off temperature difference (DTF/DT2F) or the maximum tank temperature (SMX/S2MX) is reached.

Priority heating logic will ensure to heat the tank 1 firstly.

Thermal energy transferring between 2 tanks means one tank will heat the other one. Another temperature difference between T3 and T4 will control pump R3. (see paragraph 5.4.14)

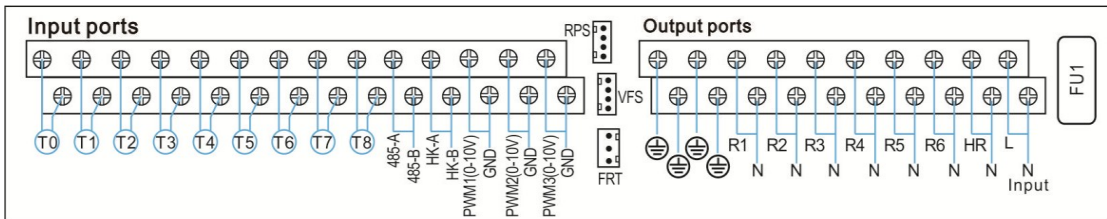
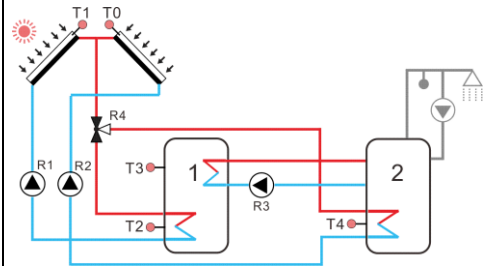

Sensor Input	Description	Relay output	Description
T0	Temperature sensor of collector 2	R1	Solar circulation pump 1
T1	Temperature sensor of collector 1	R2	Solar circulation pump 2
T2	Temperature sensor of tank 1 base	R3	Circulation pump for energy transferring
T3	Temperature sensor of tank 1 upper (optional)	R4	3-ways valve for switch tank
T4	Temperature sensor of tank 2 base	R5	Available optional auxiliary functions: 1. CIRC (DHW circulation pump) 2. OHDP (Thermal transfer function) 3. BYPR (Circulation by-pass) 4. TIMER (Timer function) 5. AH (Automatic thermostat) 6. OPARR (Parallel relay)
T5	Selectable sensor, undefined	R6	
T6	Temperature sensor for thermal energy measurement (optional)		
T7	Selectable sensor, undefined		
T8	Selectable sensor, undefined		
		HR	

System 21: Solar system with 1 collector field, 2 tanks, valve switch loading tank, preheating return of heating system

Description:

The controller calculates the temperature difference between collector sensor T1 and tank sensor T2 and T4. If the differences is larger than or identical to the adjusted switch-on temperature difference (DTO/DT2O), then solar circulation pump (R1) will be switched on, and simultaneously valve R4 turns to the corresponding tank, that tank will be loaded until the switch-off temperature difference (DTF/DT2F) or the maximum tank temperature (SMX/S2MX) is reached.

Priority heating logic will ensure to heat the tank 1 firstly.

Another temperature difference function between T5 and T6 is used to control the 3-ways valve R5 to pre-heat the heating return (see paragraph 5.4.15)

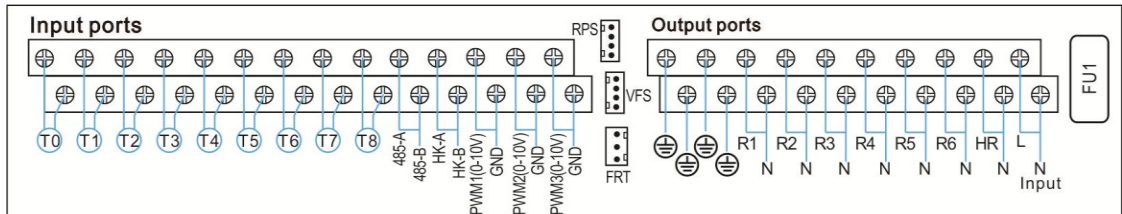
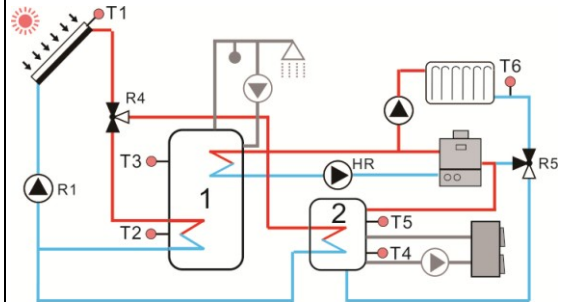

Sensor Input	Description	Relay output	Description
T0	Selectable sensor, undefined	R1	Solar circulation pump 1
T1	Temperature sensor of collector	R4	3-ways valve for heat tank
T2	Temperature sensor of tank 1 base	R5	3-ways valve for pre-heat the return
T3	Temperature sensor of tank 1 upper (optional)	R2	Available optional auxiliary functions: 1.CIRC (DHW circulation pump) 2.OHDP (Thermal transfer function) 3.SFB (Solid fuel boiler function) 4.BYPR (Circulation by-pass) 5.TIMER (Timer function) 6.AH (Automatic thermostat) 7.OPARR (Parallel relay)
T4	Temperature sensor of tank 2 base	R3	
T5	Temperature sensor of tank 2 upper for pre-heat the return (optional)	R6	
T6	Temperature sensor for thermal energy measurement		
T7	Selectable sensor, undefined		
T8	Selectable sensor, undefined		
		HR	

System 22: Solar system with 1 collector field, 2 tanks, pump switch loading tank, preheating return of heating system

Description:

The controller calculates the temperature difference between collector sensor T1 and tank sensor T2 and T4. If the differences are larger than or identical to the adjusted switch-on temperature difference (DTO/DT2O), then solar circulation pump (R1) will be switched on, and corresponding tank will be loaded until the switch-off temperature difference (DTF/DT2F) or the maximum tank temperature (SMX/S2MX) is reached.

Priority heating logic will ensure to heat the tank 1 firstly.

Another temperature difference function between T5 and T6 is used to control the 3-ways valve R4 to pre-heat the heating return (see paragraph 5.4.15)

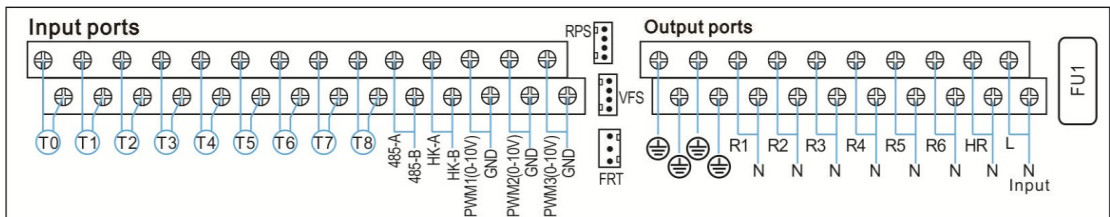
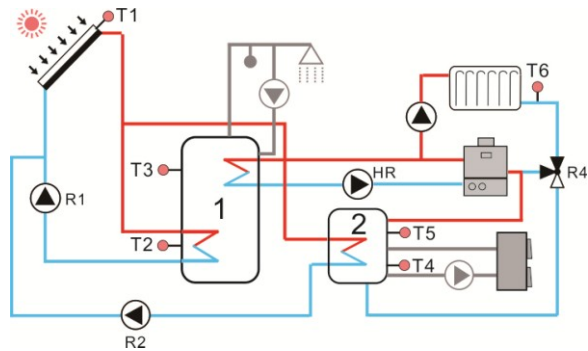

Sensor Input	Description	Relay output	Description
T0	Selectable sensor, undefined	R1	Solar circulation pump 1
T1	Temperature sensor of collector	R2	Solar circulation pump 2
T2	Temperature sensor of tank 1 base	R4	3-ways valve for pre-heat the return
T3	Temperature sensor of tank upper (optional)	R4	Available optional auxiliary functions: 1.CIRC (DHW circulation pump) 2.OHDP (Thermal transfer function) 3.SFB (Solid fuel boiler function) 4.BYPR (Circulation by-pass) 5.TIMER (Timer function) 6.AH (Automatic thermostat) 7.OPARR (Parallel relay)
T4	Temperature sensor of tank 2 base	R5	
T5	Selectable sensor, undefined (optional)	R6	
T6	Temperature sensor for thermal energy measurement		
T7	Selectable sensor, undefined		
T8	Selectable sensor, undefined		
		HR	

System 23: Solar system with east/west collector fields, 2 tanks, valve switch loading tank, preheating return of heating system

Description:

The controller calculates the temperature difference between collector sensor T1 and tank sensor T2 and T4. If the differences is larger than or identical to the adjusted switch-on temperature difference (DTO/DT2O), then solar circulation pump (R1,R2) will be switched on, and simultaneously valve R4 turns to the corresponding tank, that tank will be loaded until the switch-off temperature difference (DTF/DT2F) or the maximum tank temperature (SMX/S2MX) is reached.

Priority heating logic will ensure to heat the tank 1 firstly.

Another temperature difference function between T5 and T6 is used to control the 3-ways valve R5 to pre-heat the heating return (see paragraph 5.4.15)

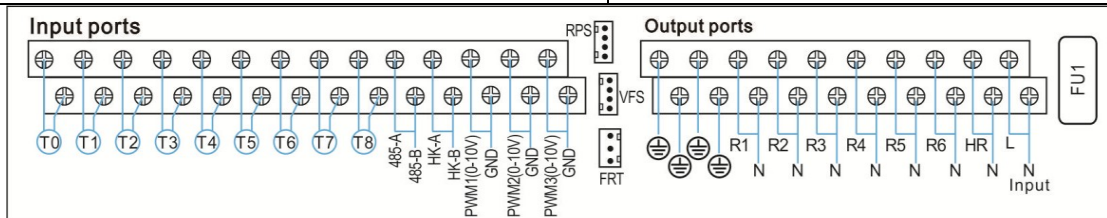
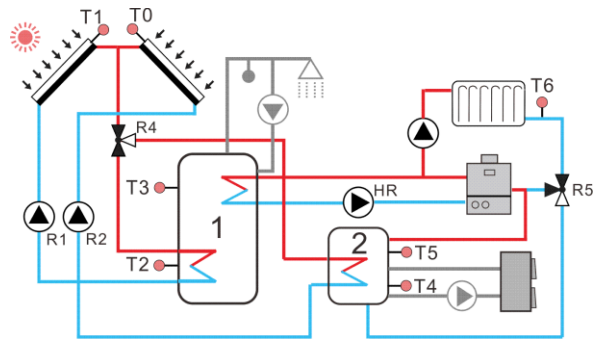

Sensor Input	Description	Relay output	Description
T0	Temperature sensor of collector 2	R1	Solar circulation pump 1
T1	Temperature sensor of collector 1	R2	Solar circulation pump 2
T2	Temperature sensor of tank 1 base	R4	3-ways valve for heat tank
T3	Temperature sensor of tank upper (optional)	R5	3-ways valve for pre-heat the return
T4	Temperature sensor of tank 2 base	R3	Available optional auxiliary functions: 1.CIRC (DHW circulation pump) 2.OHDP (Thermal transfer function) 3.SFB (Solid fuel boiler function) 4.BYPR (Circulation by-pass) 5.TIMER (Timer function) 6.AH (Automatic thermostat) 7.OPARR (Parallel relay)
T5	Selectable sensor, undefined (optional)	R6	
T6	Temperature sensor for thermal energy measurement		
T7	Selectable sensor, undefined		
T8	Selectable sensor, undefined	HR	Back-up heating

4.3 Commissioning



Before connecting the controller to the mains, ensure system is filled and ready for operation, please connecting all sensors to the input terminals, pumps or valves to the output terminals and fill the system.

After power is switch on, the controller runs an initialization phase for 5 seconds, then controller runs a commissioning menu, it leads the user through the most important adjustment channels needed for operating the system.

5 Functions and options

5.1 Overview of menu structure

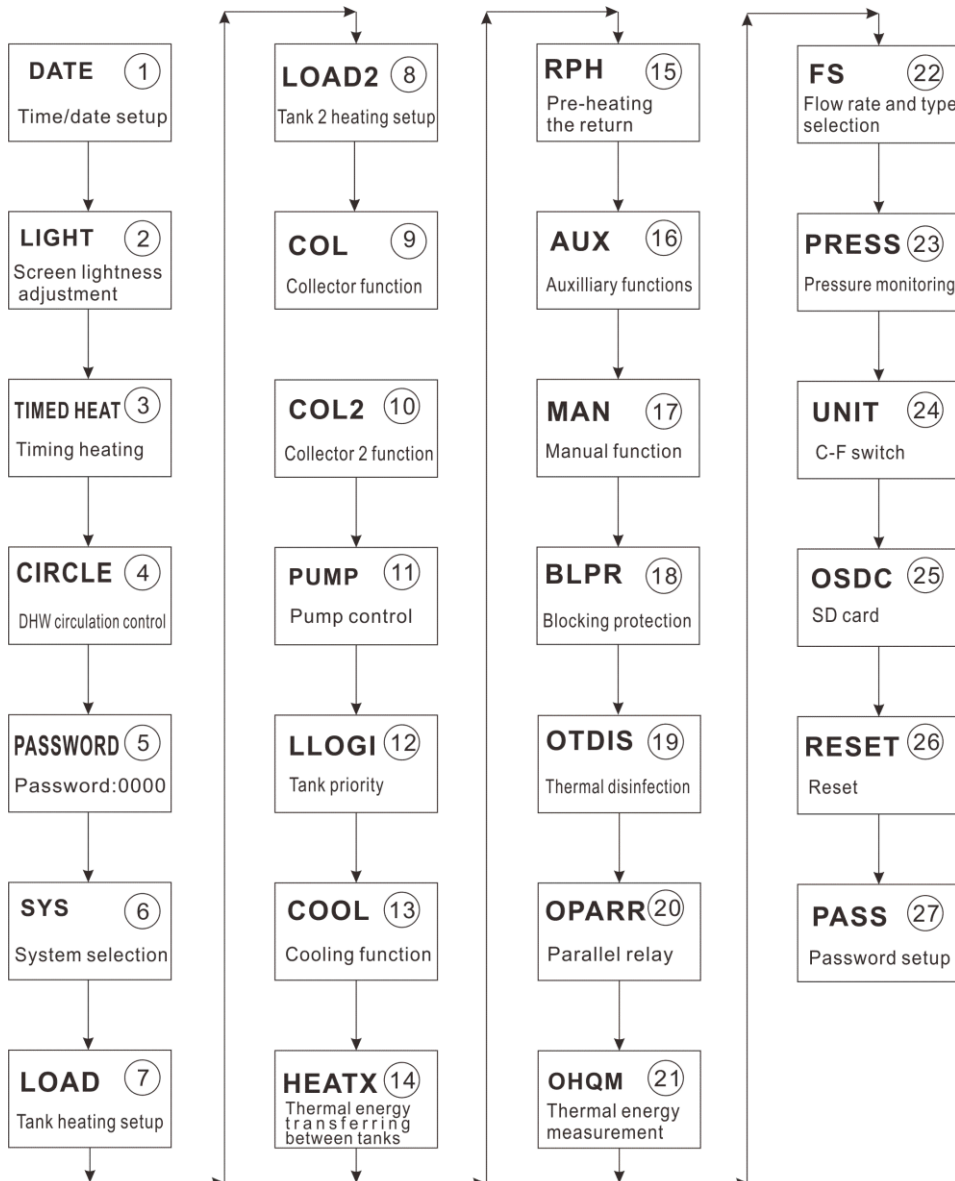

5.2 Menu operation description

- **Access main menu**
 - ▶ press “SET” button to access main menu
 - ▶ Press “↑”, “↓” to select menu
 - ▶ Press “SET” button to enter the submenu

- **Access submenu, after select a menu**
 - ▶ Press “SET” button to access submenu
 - ▶ Press “↑”, “↓” to select a submenu
 - ▶ Press “SET” button to enter option interface of submenu
 - ▶ Press “↑”, “↓” to select “ON” to open this option, select “OFF” to close this option
 - ▶ Press “SET” button to enter the value adjust interface
 - ▶ Press “↑”, “↓” to adjust value
 - ▶ Press “SET” to “ESC” confirm the value you set



Note: Enter the menu adjustment interface, if you don't press any button within 5 minutes, screen will exit the adjustment and turn to main interface.

5.3 Check value

At the normal operation mode, press “↑”, “↓” button, you can view the temperature of collector and tank, pump speed, accumulated pump running time, current day thermal energy, accumulated thermal energy, flow rate, pressure, controller running time, software version. (Blue color means: normal value, red color means: fault, grey color means: function is deactivated).



Note: enter the value check interface, if you don't press any button within 5 minutes, screen will exit the check interface and turn to main interface.

5.4 Menu function

(1) Date (Time/ Date setup)

Menu structure					
<pre> graph TD A[DATE (Main menu) ①] --> B[ADST] B --> C[00:00] C --> D[DD/MM/YYYY] B --- E[Submenu] </pre>					
Main menu	Submenu 1	Default setup	Adjust range	Adjust step	Description
Date					Date
	ADST	OFF	ON/OFF		Summer time: ADST OF 11:00 ADST ON 12:00
	Time				Hour/Minute
	Date				Day/Month/Year

- ADST: Switch on/off the auto summer function
When you deactivate the “auto summer function”, controller can run yet, “ADST” is only referring Europe 200/84/EG, only suitable for Europe union country.
- Time: Set clock and time; firstly, adjust hour, then minute.
- Date: Set date, in sequence day, month, and year.



Note: In the case power to controller is switched-off, date and time will be remembered in controller for 36 hours.

(2) Light (Screen lightness adjust)

Menu Structure					
LIGHT (Main menu) ②					
↓					
LIGHTESS					
—— Submenu					
Main menu	Submenu 1	Default setup	Adjust range	Adjust step	Description
Light					Screen lightness adjust
	Lightness	50%	5%-100%	10%	Lightness valve adjust

- Adjust desired TFT screen lightness.

(3) Timed Heat (Timing heating)

Main menu	Submenu 1	Submenu 2	Default setup	Adjust range	Adjust step	Description
Timed Heat						
	NOAUX					No back-up function
	Electric		Electric			Electrical heating
	Boiler					Boiler
		T_sensor	T3	T2, T3		Select sensor for the back-up heating
		SMT-HT	OFF	ON/OFF		Intelligent heating mode
		t H1O	04:00 / 40°C	00:00-23:59 / 0.0-93°C	0.5°C	Set the start time and temperature for the first-time frame
		t H1F	05:00 / 50°C	00:00-23:59 / 0.0-95°C	0.5°C	Set the close time and temperature for the first-time frame
		t H2O	10:00 / 40°C	00:00-23:59 / 0.0-93°C	0.5°C	Set the start time and temperature for the second-time frame
		t H2F	10:00 / 45°C	00:00-23:59 / 0.0-95°C	0.5°C	Set the close time and temperature for the second-time frame
		t H3O	17:00 / 50°C	00:00-23:59 / 0.0-93°C	0.5°C	Set the start time and temperature for the third-time frame
		t H3F	22:00 / 55°C	00:00-23:59 / 0.0-95°C	0.5°C	Set the close time and temperature for the third-time frame

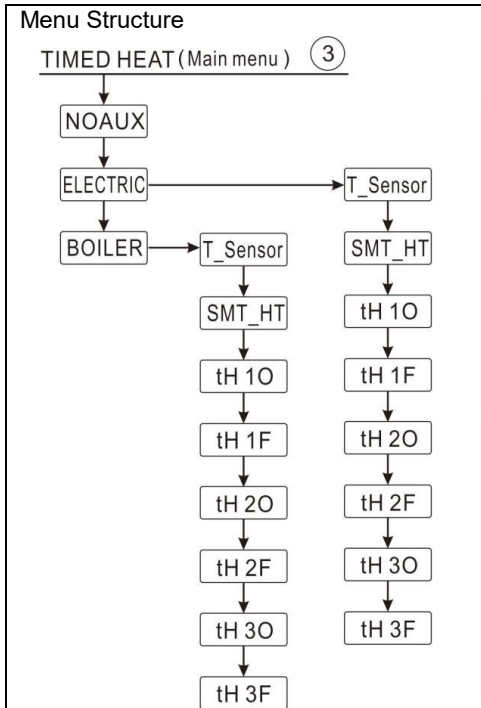

Submenu

- NoAux: No back-up heat source
- Electric: Electrical heater as heating back-up
- Boiler: Boiler as heating back-up
- T_Sensor: Select sensor for timing heating function, default sensor is T3

● **Timing heating**

Timing heating function is independent of solar system; it is used to control back-up heat source to heat tank.

Timing heating function is run at the pre-set time frame, 3-time frames can be set, start time and close time can be set by press button, per press means 1 minute. If you set the start time and close time with a same value, which means within this time frame, the timing heating function is switched-off. For example, if you want to run the back-up heating from 06:00 am to 09:00 am, then you set t1O is 06:00 am, set t1F is 09:00 am, default setting of the first timing section is 06:00 am to 22:00 pm, if all time is set with 00:00 value, that means the timing heating function is switch-off.

● **SMT_HT: Intelligent heating**

At the case that solar energy is insufficient to heat the tank, in order to ensure user has sufficient hot water, controller will check the temperature of tank automatically at the pre-set time, if tank's temperature is not reached to the desired temperature, then back-up heat device will be triggered, and when tank's temperature rises up to the desired value, then back-up heat device stops.

● **Factory default set:**

- Default at 13:00 of the first-time frame to trigger the back-up heat device to heat tank to 30°C, and then stop
- Default at 14:00 of the second-time frame to trigger the back-up heat device to heat tank to 35 °C, and then stop
- Default at 15:00 of the third-time frame to trigger the back-up heat device to heat tank to 40 °C, and then stop
- Default at 16:00 of the fourth time frame to trigger the back-up heat device to heat tank to 45 °C, and then stop
- Default at 17:00 of the fifth time frame to trigger the back-up heat device to heat tank to 50 °C, and then stop

(4) Circle (DHW circulation pump control function)

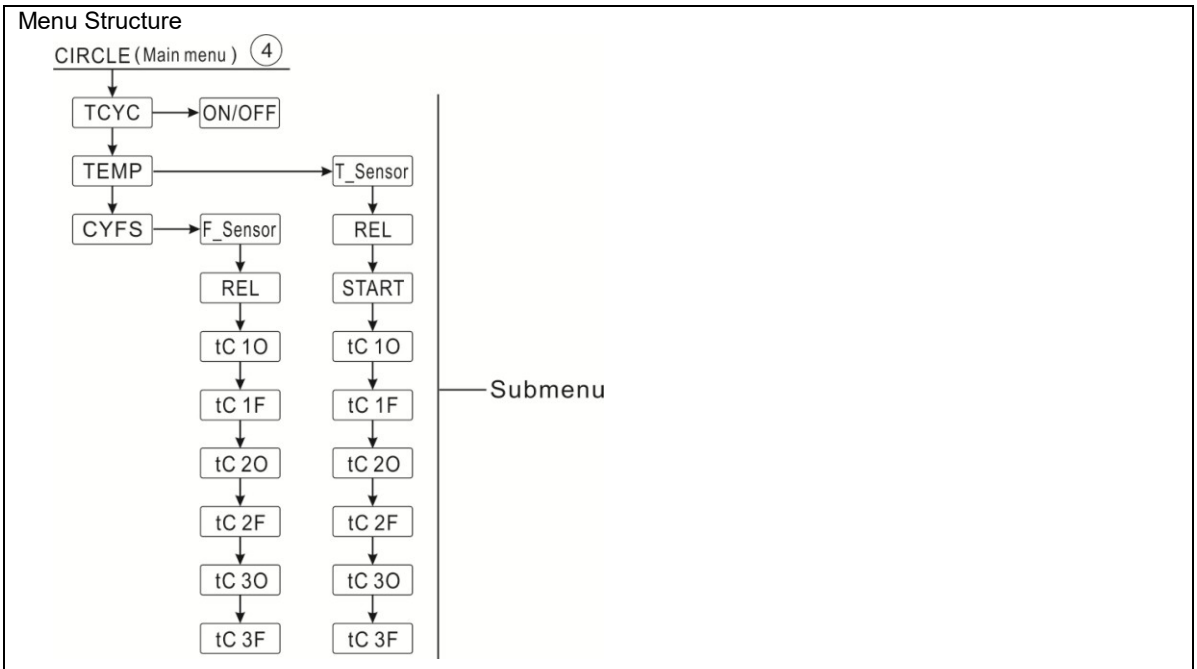

Main menu	Submenu 1	Submenu 2	Default setup	Adjust range	Adjust step	Description
*Circle						DHW circulation control
	TCYC		OFF	ON/OFF		DHW circulation function on/off
	TEMP					DHW temperature control
	CYFS					DHW flow switcher control
		T_Sensor F_Sensor		Defined according to the selected system		Sensor selection for DHW circulation function. Connect flow switcher
		REL		Defined according to the selected system		DHW circulation output
		START	ON	ON/OFF		Threshold of tank temperature 2°C higher than the DHW circulation switch-off setpoint
		t C1O	05:00 / 40°C	00:00-23:59 / 5-53°C		Set the start time and temperature for the first-time frame
		t C1F	07:00 / 45°C	00:00-23:59 / 7-55°C		Set the close time and temperature for the first-time frame
		t C2O	11:00 / 40°C	00:00-23:59 / 5-53°C		Set the start time and temperature for the second-time frame
		t C2F	13:00 / 45°C	00:00-23:59 / 7-55°C		Set the close time and temperature for the second-time frame
		t C3O	17:00 / 40°C	00:00-23:59 / 5-53°C		Set the start time and temperature for the third-time frame

		t C3F	22:00 / 45°C	00:00-23:59 / 7-55°C		Set the close time and temperature for the third-time frame
--	--	-------	--------------	----------------------	--	---

- **TEMP (Temperature controlled DHW circulation within the preset 3-time frames)**

This controller provides an output for running DHW circulation pump, which can be controlled by a temperature, at this case, an extra circulation pump (connect to the output REL option) and an extra temperature sensor mounted on the hot water return pipe (connect to the input which set under T_sensor menu) should be installed in the system. When the temperature of DHW return is lower than the preset switch-on temperature, circulation pump is triggered, until temperature rises up to the switch-off temperature, pump is stopped.

- **START (precondition for triggering the DHW circulation pump) switch on/off**

START ON: just in the case that tank's temperature sensor is 2°C higher than the preset switch-off temperature setpoint, and then DHW circulation pump can be triggered.

i Note: in system 14 ~ 20 which has thermal energy transferring function, DHW circulation is from the second tank (refer paragraph 4.2 system description), then the sensor of START on/off condition is related to tank 2.

- **CYFS (Flow switcher controlled DHW circulation within the preset 3-time frames)**

This controller can provide an output for running DHW circulation pump controlled by a flow switcher (input port F-Sensor option), which is mounted on the cold-water pipe. At this case, when you open the water tap, flow switcher will obtain the flow signal and trigger the circulation pump (connect to output REL), hot water from tank is pumped into the tap. Running time of circulation pump is adjustable, running time is run out, then pump is stopped.

Water tap is similar to a remote-control signal to trigger the pump. This circulation control principle is an economic and user-friendly control solution.

Open the water tap for a short while, flow switcher which mounted on the inlet pipe of tank gets the flow signal, then controller will trigger DHW circulation pump RX and pump hot water from tank into the circulation pipe, then when you open the tap again, how water flows out immediately. The running period of DHW pump is controlled by the time parameter named running time of DHW pump RX, when time is finished, pump is stopped. When tap is closed and

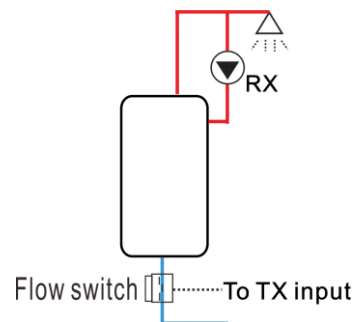

to avoid the energy waste through circulation pipe, pump will be stopped when the running time is out. To avoid the to trigger the pump again just after it is stopped (short circulation of pump), another parameter named interval time will be defined to control the retrigger of pump.

Pump is triggered by time, within a running time frame, as default set, pump runs for 3 minutes (adjust range 1-30MIN) and then ceases for 15 minutes (adjust range 0-60MIN), same process repeated within the running time frame.

If it is needed to close one-time frame, just set the start time and stop time at a same value (e.g. 05:00 starts, 05:00 stops)

Note:

- 1) To prevent water in the tank from mixing with water in the circulation pipe, check valve must be installed before the circulation pump.
- 2) If parameter of pump interval time (CYCF) is set to 0 minute, turn on water tap, DHW circulation pump will be triggered and keep running within the time period, Turn off water tap, pump will stop automatically.

Default factory set of time frame:

- The 1st time-section: start at 05:00 am, and close at 07:00 am
- The 2nd time-section: start at 11:00 am, and close at 13:00 pm
- The 3rd time-section: start at 17:00 am, and close at 22:00 am

Flow switcher fitting:

- material of fitting: brass
- house: plastic
- connection: G3/4
- Leaf-spring: MAX 300V DC/1A



Note:

- 1) Pay attention to the flow direction of flow switcher.
- 2) Wire connection to controller input port regardless of polarity.
- 3) Flow switcher is not included in the controller delivery accessories, purchase separately if need.

(5) Password

Menu Structure					
Main menu	Submenu 1	Default setup	Adjust range	Adjust step	Description
Password		0000			Password

Through password set to limit the user to access some parameters, 4 digitals needed. Default is 0000.

(6) SYS (System selection)

Menu Structure					
Main menu	Submenu 1	Default setup	Adjust range	Adjust step	Description
Password		0000			Password
SYS					System
	SYS	1	1--23		Select system

Each system has pre-programmed options and adjustments which can be activated or changed respectively if necessary. Select the system first (1-23 systems available)

(7) LOAD / (8) LOAD2 (Tank 1/Tank 2 heating setup)

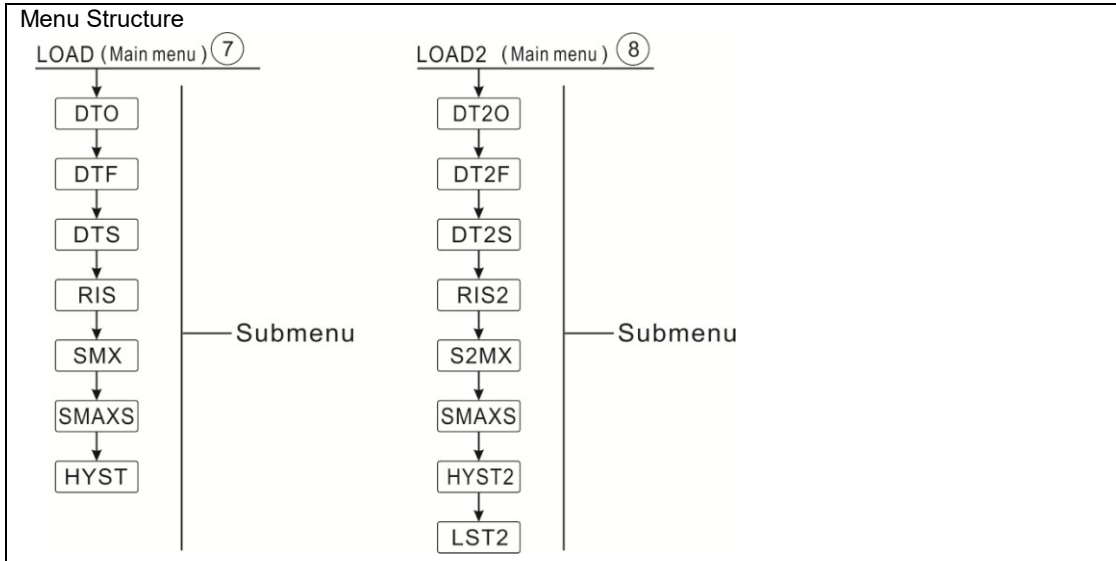

Main menu	Submen u 1	Submen u 2	Default setup	Adjust range	Adjust step	Description
LOAD						Tank 1 heating setup
	DTO		6K	1-50K	0.5K	Tank 1 switch-on temperature difference
	DTF		4K	0.5-49.5K	0.5K	Tank 1 switch-off temperature difference
	DTS		10K	1.5-50K	0.5K	Setup of temperature difference for tank1's pump speed control
	RIS		2K	1-20K	1K	Setup of rise step for tank1's pump speed control
	SMX		60°C	4-95°C	1°C	Maximum water temperature of tank 1
	SMAXS		T3	T2, T3		Select the sensor for the maximum water temperature of tank 1
	HYST		2K	0.1-10K	0.1K	hysteresis of the maximum water temperature of tank 1
	LST		ON	ON/OFF		Set the tank to be heated (if LTS or LTS2 is set 0, then only one tank is considered in the system) In the system with only one tank, there is no LST submenu.
LOAD2						Tank 2 heating setup
	DT2O		6K	1-50K	0.5K	Tank 2 switch-on temperature difference
	DT2F		4K	0.5-49.5K	0.5K	Tank 2 switch-off temperature difference
	DT2S		10K	1.5-50K	0.5K	Setup of temperature difference for tank2's pump speed control
	RIS2		2K	1-20K	1K	Setup of rise step for tank2's pump speed control
	S2MAX		60°C	4-95°C	1°C	Maximum water temperature of tank 2

	SMAXS		T4	T4. T5		Select the sensor for the maximum water temperature of tank 2
	HYST2		2K	0.1-10K	0.1K	hysteresis of the maximum water temperature of tank 2
	LST2		ON	ON/OFF		Set the tank to be heated (if LTS or LTS2 is set 0, then only one tank is considered in the system)

● **DT Temperature difference**

The controller works as a standard differential controller. If the temperature reaches or exceeds the switch-on temperature difference (DTO), then pump switches on. When the temperature difference reaches or falls below the adjusted switch-off temperature difference (DTF), the respective relay switches off.

 **Note:** The switch-on temperature difference (DTO) must be 0.5 K higher than the switch-off temperature difference (DTF). The set temperature difference must be at least 0.5 K higher than the switch-on temperature difference.

Note: In systems with 2 tanks or tank heating in layers, 2 separate menus (LOAD and LOAD 2) will be displayed.

● **Speed control**

If the temperature reaches or exceeds the setpoint of the switch-on temperature difference (DTO), the pump switches on and keeps running at 100% speed for 10s. Then, the speed is reduced to its minimum pump speed.

If the temperature difference reaches the setpoint of temperature difference (DTS), the pump speed increases by one step (10%). The response of the controller can be adapted via the parameter RIS. If the difference increases by the adjustable rise value RIS, the pump speed increases by 10% until the maximum pump speed of 100% is reached. If the temperature difference decreases by the adjustable rise value RIS, pump speed will be decreased by one step 10%.

 **Note:** To enable speed control, the corresponding pump has to be set to (MIN, MAX) and the corresponding control relay has to be set to (PULS, PSOL, PHEA or 0-10 V) (under menu PUMP).

● **SMX Setup of the maximum tank temperature**

If the tank temperature reaches the adjusted maximum temperature, the tank will no longer be heated in order to avoid damage caused by overheating. If the maximum tank temperature is exceeded, Max is displayed.

The sensor for tank maximum limitation (SMAXS) can be selected. The maximum limitation always refers to the sensor selected. The switch-on hysteresis (HYST) is

selectable. Default is 2°C, for example, when tank maximum temperature is set to 70°C, then at 68°C, maximum tank temperature protection function is deactivated automatically.

i **Note:** In systems with 2 tanks or tanks heating in layers, 2 separate menus (**LOAD** and **LOAD 2**) will be displayed.

● **LST2 Heating tank**

In systems with 2 tanks, the second tank can be switched off with the parameter **LST2**. If **LST2** is adjusted to **OFF**, the system runs like the 1-tank system. But the representation in the display remains 2 tanks.

(9) COL Collector 1 function / (10) COL2 Collector 2 function

Menu structure:

Main menu	Submenu 1	Submenu 2	Default setup	Adjust range	Adjust step	Description
COL						Collector 1 function
	CEM		ON			On/OFF of collector 1 emergency shut-down function
		CEM	130°C	80-200°C	1°C	Temperature for collector emergency shut-down (hysteresis 10°C)
	OCCO		OFF			On/OFF of collector cooling function
		CMAX	110°C	70-160°C	1°C	Temperature of collector cooling (hysteresis 5°C)
	OCMI		OFF			On/OFF of Minimum collector temperature
		CMIN	10°C	10-90°C	1°C	Minimum temperature of collector
	OCFR		OFF			On/OFF of anti-frost function
		CFRO	4°C	-40-8°C	0.5°C	Switch-on temperature for anti-frost function
		CFRF	5°C	-39-9°C	0.5°C	Switch-off temperature for anti-frost function

	OTCO					Delayed-measure function of vacuum tube collector
		TCST	07:00	00:00-23:00	30min	Start of delayed-measure function of vacuum tube collector
		TCEN	19:00	00:00-23:00	30min	Close of delayed-measure function of vacuum tube collector
		TCRU	30s	30-300s	1s	Running time of delayed-measure function of vacuum tube collector
		TCIN	30min	5-60min	1min	Interval of delayed-measure function of vacuum tube collector
COL2						Collector 2 function
	CEM2		ON			On/OFF of collector 2 emergency shut-down function
		CEM2	130°C	80-200°C	1°C	Temperature for collector 2 emergency shut-down (hysteresis 10°C)
	OCCO2		OFF			On/OFF of collector 2 cooling function
		CMAx2	110°C	70-160°C	1°C	Temperature of collector 2 cooling (hysteresis 5°C)
	OCMI2		OFF			On/OFF of Minimum collector 2 temperature
		CMIN2	10°C	10-90°C	1°C	Minimum temperature of collector 2
	OCFR2		OFF			On/OFF of anti-frost function
		CFRO2	4°C	-40-8°C	0.5°C	Switch-on temperature for anti-frost function
		CFRF2	5°C	-39-9°C	0.5°C	Switch-off temperature for anti-frost function
	OTCO2					Delayed-measure function of vacuum tube collector 2
		TCST2	07:00	00:00-23:00	30min	Start of delayed-measure function of vacuum tube collector 2
		TCEN2	19:00	00:00-23:00	30min	Close of delayed-measure function of vacuum tube collector 2
		TCRU2	30s	30-300s	5s	Running time of delayed-measure function of vacuum tube collector 2
		TCIN2	30min	5-60min	1min	Interval of delayed-measure function of vacuum tube collector 2

● **CEM Collector emergency shutdown**

When the collector temperature exceeds the setpoint of collector emergency temperature, solar pump (R1 / R2) switches off in order to protect the system components from overheating (collector emergency shutdown). If the maximum collector temperature is exceeded, "Emerg" is displayed on the screen.



Note: In systems with east- / west collectors, 2 separate menus (**COL** and **COL 2**)

will be displayed.

Warning! Risk of injury! Risk of system damage by pressure surge! If water is used as the heat transfer fluid in pressure systems, water will boil at 100 °C. Do not set the collector limit temperature higher than 95 °C.

- **OCCO Collector cooling**

The collector cooling function keeps the collector rise temperature within the operating range by heating the tank. If the tank temperature reaches 95 °C, the cooling function will be switched off for safety reasons.

When the tank temperature exceeds the setpoint of the maximum tank temperature (SMX), then solar system switches off. If the collector temperature rises to its setpoint of the maximum collector temperature (CMAX), the solar pump will be switched on again and transfer heat from collector to tank until the collector temperature drops below the maximum collector temperature (CMAX) of 5°C. The tank temperature may then exceed its maximum temperature, but only up to 95°C (emergency shutdown of the tank), and “Emerg” is displayed, system stops.

If the collector cooling is active, “Cool” is displayed.

This function is only available when the system cooling function (OSYC) and the heat transfer function (OHDP) are not activated.

In systems with east- / west collectors two separate menus (**COL** and **COL 2**) will be displayed.

- **OCMI Collector minimum temperature**

The minimum collector temperature is the minimum switch-on temperature which must be exceeded for the solar pump (R1 / R2) to be switched on. If the collector temperature drops below the adjusted minimum temperature, Min is displayed.



Note: In the systems with east- / west collectors two separate menus (**COL** and **COL 2**) will be displayed.

- **OCFR Collector anti-frost function**

Collector anti-frost function activates the reverse heating circuit between the collector and the tank when the collector temperature drops below the adjusted temperature **CFRO**.

This will protect the fluid from freezing or coagulating. If **CFRF** is exceeded, the solar pump will be switched off again.

During the anti-frost function process, when the temperature of the water tank drops below 3°C, and then the circulation pump stops running. When the temperature of the water tank rises to 5°C, the circulation pump continues to run. When the temperature of the water tank drops to 9°C, electric heating will be started to heat to 15°C.

If collector anti-frost function is activated, “Antifr” is displayed on the screen.



Note: In systems with east- / west collectors 2 separate menus (**COL** and **COL 2**) will be displayed.

Note: in systems with two tanks, anti-frost function gives priority to circulating tank 2, and when temperature of tank 2 drops below 3°C, it turns to circulating water tank 1.

Note: Since this function uses the limited heat quantity of the tank, the anti-frost function should be used only in regions with few days of temperatures around the freezing point.

● **OTCO Vacuum tube collector function**

This function is used for improving the switch-on behavior in systems with non-ideal sensor positions (e. g. with some tube collectors).

This function operates within an adjusted time frame. It activates the collector circuit pump for an adjustable runtime between adjustable pauses in order to compensate for the delayed temperature measurement.

If the runtime (TCRU) is set to more than 10s, the pump will be run at 100% for the first 10s of the runtime. For the remaining runtime, the pump will be run at the adjusted minimum speed.

If the collector sensor is defective or the collector is blocked, this function is suppressed or switched off.

In 2-collector fields systems, the tube collector function is available for each individual collector field.

In 2-collector fields systems, the tube collector function will affect the inactive collector field only. The solar pump of the active collector field will remain switched on until the switch-off conditions are fulfilled.

(11) PNMP Pump control

Menu Structure							
Main menu	Submenu 1	Submenu 2	Submenu 3	Default setup	Adjust range	Adjust step	Description
PUMP							Pump control mode
	PUMP1(2,3)						Select pump between pump1/pump2/pump3
		ONOF					ON/OFF of pump function

							(for pump without speed control)
		PULS	MIN1 (2, 3) MAX1 (2, 3)	50% 100%	20-95% 25-100%	5% 5%	Pulse control (for pump which can be On or off by semi-conductive relay)
		PSOL	MIN1 (2, 3) MAX1 (2, 3)	50% 100%	20-95% 25-100%	5% 5%	PWM solar pump
		PHEA	MIN1 (2, 3) MAX1 (2, 3)	50% 100%	20-95% 25-100%	5% 5%	PWM heating pump
		0-10V	MIN1 (2, 3) MAX1 (2, 3)	50% 100%	20-95% 25-100%	5% 5%	0-10V signal control pump speed

With this parameter, the relay control type can be adjusted. The following types can be selected:

- Adjustment for standard pump without speed control: ON/OFF: Pump on / pump off
- Adjustment for standard pump with speed control: PULS: Burst control via semiconductor relay
- Adjustment for high-efficiency pump (HE pumps)
 - ✧ PSOL: PWM solar pump
 - ✧ PHEA: PWM heating pump
 - ✧ 0-10: Speed control via 0 - 10 V signal



Note: more information about connection of high efficiency pump see the paragraph 3.3.

● **Minimum pump speed**

Under the adjustment menu MIN1 (2, 3), a relative minimum speed for connected pumps can be allocated to the outputs R1, R2 and R3.



Note: When a relay is used to control the device, which is not speed-controlled (e. g. valves), then the pump speed value of the corresponding relay must be set to 100 % or the control type must be set to ON/OFF in order to deactivate pump speed control.

● **Maximum pump speed**

Under the adjustment menu MAX1 (2, 3), a relative maximum speed for connected pumps can be allocated to the outputs R1, R2 and R3.



Note: When a relay is used to control the device, which is not speed-controlled (e. g. valves), the pump speed value of the corresponding relay must be set to 100 % or the control type must be set to ON/OFF in order to deactivate pump speed control.

● **PWM Relay allocation for PWM outputs**

Under menu of PWM1, PWM2, PWM3, a relay can be allocated to a PWM output; PWM1 for R1, PWM2 for R2, PWM3 for R3.

useful heat can be added, it will be loaded for the Circulation time. After this, the loading process stops and the controller monitors the increase in collector temperature during the loading break time Load. break. If it increases by 2 K, the break time timer starts again to allow the collector to gain more heat. If the collector temperature does not increase sufficiently, the subordinate store will be loaded again for the Circ. time as before.

As soon as the switch-on condition of the priority store is fulfilled, it will be loaded. If the switch-on condition of the priority store is not fulfilled, loading of the second store will be continued. If the priority store reaches its maximum temperature, store sequence control will not be carried out.

In systems with 2 tanks or tank heating in layers, all tanks or zones will be heated to its preset temperature firstly (according to the priority and sequence control logic). Only when the temperature setpoint of tanks or zones is exceeded, then they just can be heated to their maximum temperature continuously, and it is also heated according to the priority and sequence control logic.

- **OSTS Tank set option**

If the priority tank reaches its temperature setpoint, then subordinate tank will be heated until to its temperature setpoint. After this, priority tank can be heated to its maximum temperature (SMX), and then system is switched to heat the subordinate tank. This function is suitable for the system with 2 tanks.

- **OSE Extend heating option**

In the systems with 2 pumps, a extend heating function OSE can be activated, as soon as the adjustable extend temperature difference **DTSE** between the collector and the priority tank is reached, the second tank will be heated in parallel unless it is blocked. If the extend temperature difference drops below **DTSE 5K**, the pump is switched off. The collector temperature must be higher than the tank temperature.

- **PDELR Pump delay running**

Considering the trigger-on time of the electromagnetic valve this function delays the start of the pump, if this function is activated, corresponding valve relay is triggered firstly, and pump is delayed to start in 20 seconds.

- **Successive heating (Successive 1 and Successive 2)**

Successive heating means that the priority tank will be heated up to its maximum temperature (SMX). If it is reached, the second tank just will be heated. If the temperature of the first tank drops below the tank temperature setpoint, regardless of whether the switch-on conditions of the priority tank or of the subordinate tank are fulfilled or not, the second tank will no longer be heated. If both tanks have been heated to their temperature setpoint, the same process described above will take place until the tanks have reached their maximum temperature.

● **Parallel heating option**

In the systems with 2 pumps, if a parallel heating function is set, then 2 tanks can be heated simultaneously; in systems with 3-ways valves, tank which temperature is lower is heated firstly until its temperature is 5K higher than the others. Then the other tank can be heated. 2 tanks are heated alternately by 5K temperature difference.

(13) COOL Cooling function

Menu Structure						
<pre> graph TD COOL["COOL (Main menu) 13"] --> OSYC COOL --> OSTC COOL --> DTST OSTC --> DTCO OSTC --> DTST DTST --> DTCF DTST --> HDSEN HDSEN --> OTPUM OTPUM --> HDREL </pre>						
Main menu	Submenu 1	Submenu 2	Default setup	Adjust range	Adjust step	Description
COOL						Cooling function
	OSYC		0FF	ON/OFF		System cooling
	OSTC		0FF	ON/OFF		Tank cooling
		DTCO	20K	1-30K	0.5K	Switch-on temperature difference of cooling function
		DTCF	15K	0.5-29.5K	0.5K	Switch-off temperature difference of cooling function
	OHDP		OFF	ON/OFF		Heat transfer – by external heat exchanger (depend on the system, only when output is available, function can be activated)
		OTST	80°C	20-160°C	1°C	Temperature of heat transfer hysteresis 5°C
		HDSEN	Col	Col / Load		Object sensor for external heat exchanger – collector sensor or tank sensor (SMAXS)
		OTPUM	ON	OTPUM ON= Pump logic OTPUM OFF=Valve logic		Control logic select between pump and valve
		HDREL				Output relay selection (depend on the selected system)

3 Different cooling functions for different devices can be activated: system cooling, tank cooling and external radiator heat transfer.

- **OSYC System cooling**

The system cooling function aims to keep the running of solar system for a longer time. The function overrides the maximum tank temperature to provide thermal relief of the collector field and the heat transfer fluid on hot days. If the tank temperature is higher than the adjusted maximum tank temperature and the switch-on temperature difference **DTCO** is reached, the solar pump remains switched on or will be switched on. Solar heating is continued until either the temperature difference falls below the adjusted value **DTCF** or the collector emergency shutdown temperature **CEM** is reached. When system cooling function is activated, "System Cooling" displays on the screen.

 **Note:** This function will only be available when the collector cooling function and external radiator heat transfer function are not activated.

- **OSTC Tank cooling**

When the tank cooling function is activated, the controller aims to cool down the tank during the night in order to prepare it for solar heating on the following day. If the adjusted maximum tank temperature **SMAX1**, **SMAX2** is exceeded and the collector temperature falls below the tank temperature and down to the switch on temperature difference **DTCO** of this cooling function, then system will be activated in order to cool down the tank by releasing the energy through the collector. When tank cooling function is activated, "Store Cooling" displays on the screen.

 **Note:** if tank temperature reaches to 95 °C, all cooling functions will be locked. Hysteresis switch on temperature difference is 5K.

- **OHDP external radiator heat transfer**

External radiator heat transfer function can be used to transfer the excess heat generated from strong solar irradiation by an external heat exchanger (e. g. fan coil), it is for keeping the collector temperature within its operating range. For this function, an extra output should be added.

External radiator heat transfer function can either control an additional pump or valve (**OTPUM ON** = pump logic, **OTPUM OFF** = valve logic). Default is **OTPUM ON** = pump logic.

- ◇ **Heat transfer by external pump logic**

If the collector temperature or tank temperature reaches the adjusted switch-on temperature (**OTST**), the allocated relay for pump is energized at 100 % speed; if the collector temperature falls by 5 K below the adjusted collector over-temperature, the relay will be switched off. In the pump logic, the heat transfer function works independent from solar heating.

- ◇ **Heat transfer by valve logic**

If the collector temperature reaches the adjusted collector over-temperature, the

allocated relay will be energized 100% in parallel to the solar pump. If the collector temperature falls by 5K below the adjusted collector or tank over-temperature, the relay will be switched off.

Heat transfer function can be used to release excess heat either from collector or from tank, (HDSEN Col= transfer collector's excess heat, HDSEN Load= transfer the excess heat from tank)

Below is the example of this application for reference.

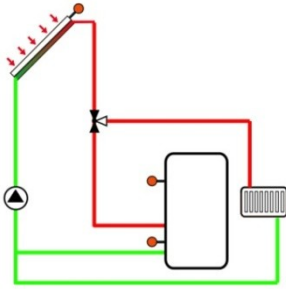

Valve logic of collector heat transfer

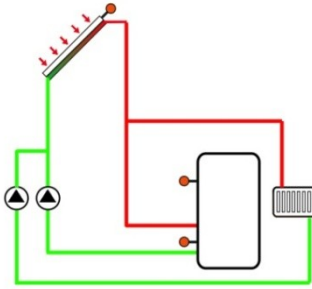

Pump logic of collector heat transfer

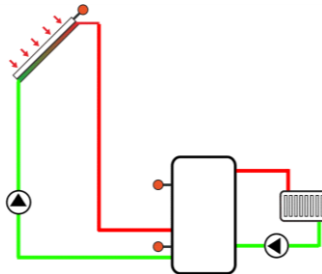

Tank pump logic of tank heat transfer



This icon displays on the screen, it means heat transfer function is activated.



This icon displays on the screen, it means heat transfer function is in operation.



Note: The adjustable collector over-temperature **OTST** is blocked against the collector emergency temperature **CEM** by 10 K. This function will only be available when the collector cooling function "OCCO" and the system cooling function "OSYC" are deactivated.

Depending on the selected system, heat transfer function can be triggered only when the output is available.

(14) HEATX Heat exchange between tanks



Main menu	Submen u 1	Submen u 2	Default setup	Adjust range	Adjust step	Description
HEATX						Heat exchange between tanks
	DTHXO		6K	1-50K	0.5K	Switch-on temperature of HEATX function
	DTHXF		4K	0.5-49.5K	0.5K	Switch-off temperature of HEATX function
	DTHXS		10K	1.5-50K	0.5K	Pump speed control – temperature difference between tanks
	RISHX		2K	1-20K	1K	Pump speed control- rise step between tanks
	MXHXO		60°C	0.5-95°C	0.5°C	Maximum temperature of the heated tank
	MNHXO		60°C	0.5-89.5°C	0.5°C	Minimum temperature of heat source tank

The heat exchange function can be used for transferring heat from a heat source to a heat sink.

The relay (system-dependent) is energized when all switch-on conditions are fulfilled:

- The temperature difference (DTHXO) between the sensors heat source and heat sink exceeds the switch-on temperature difference.
- The temperature at the heat source sensor exceeds its minimum temperature (MNHXO)
- The temperature at the heat sink sensor drops below its maximum temperature (MXHXO)

When the set temperature difference is exceeded, pump speed control starts. For every decrease or increase by the rise value, the pump speed will be adjusted by 10%.

(15) RPH Return preheating

Main menu	Submenu 1	Submenu 2	Default setup	Adjust range	Adjust step	Description
RPH						Return preheating function
	Tank					Select tank sensor
	DTRPO		6K	1-50K	0.5K	Switch-on temperature difference
	DTRPT		4K	0.5-49.5K	0.5K	Switch-off temperature difference
	MNRPH		30°C	0.5-89.5°C	0.5°C	Minimum temperature of heating return pipe (hysteresis 5°C)

The return preheating function can be used for transferring heat from a heat source to the heating circuit return.

The relay (system-dependent) is energized when both switch-on conditions are fulfilled:

- The temperature difference between the sensors of tank and sensor of the heating circuit return exceeds the switch-on temperature difference (DTRPO).
- The temperature at the heating circuit return exceeds its minimum temperature (MNRPH) .

The switch-on hysteresis is -5 K.

(16) AUX Auxiliary functions

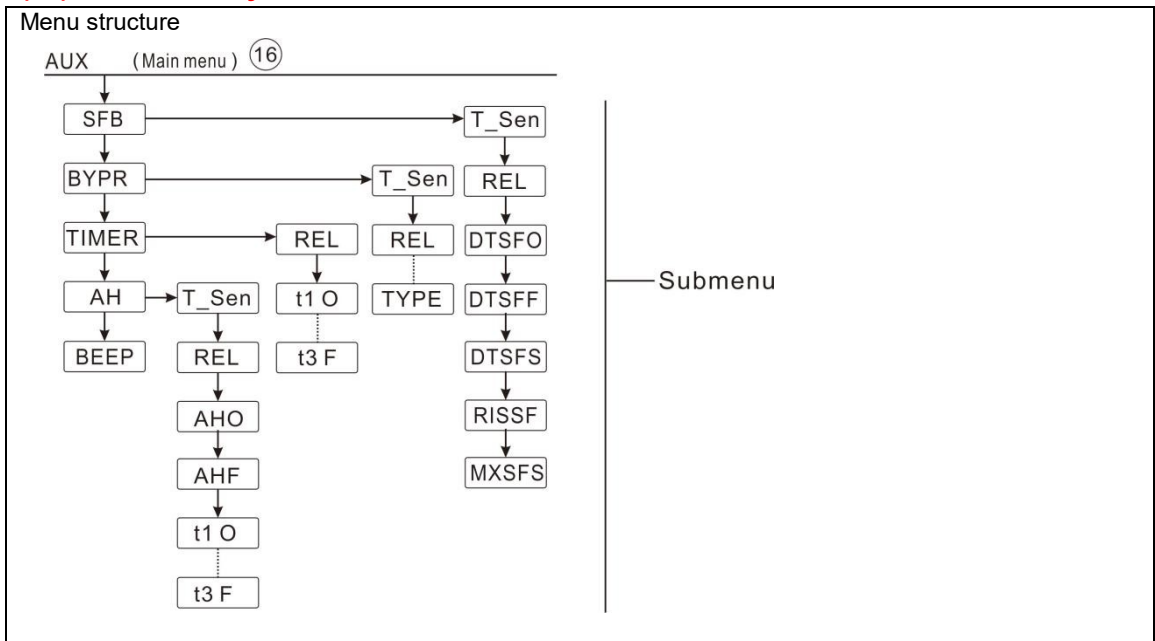

Main menu	Submen u 1	Submen u 2	Default setup	Adjust range	Adjust step	Description
AUX						Auxiliary function
	SFB		OFF	ON/OFF		Solid fuel boiler function
		T_Sen				Sensor for solid fuel boiler function
		REL				Output for solid fuel boiler circulation pump
		DTSFO	6K	1-50K	0.5K	Switch-on temperature difference
		DTSFF	4K	0.5-49.5K	0.5K	Switch-off temperature difference
		DTSFS	10K	1.5-50K	0.5K	Pump speed control – setup of temperature difference
		RISSF	2K	1-20K	1K	Pump speed control – setup of rise step
		MXSFS	60°C	0.5-95°C	0.5°C	Maximum shutdown temperature of tank
		MNSFO	60°C	0.5-89.5°C	0.5°C	Minimum start temperature of solid fuel boiler
	BYPR		OFF	ON/OFF		Bypass function
		T_Sen				Sensor for bypass function
		REL				Output for bypass circulation pump (or 3-ways valve)
		TYPE	VALV	VALV / PUMP		Control logic select between pump or valve
	TIMER		OFF	ON/OFF		Timer function
		REL				Output for timer function
		t 1O	00:00	00:00-23:59		Start time of the 1 st time-section
		t 1F	00:00	00:00-23:59		Close time of the 1 st time-section
		t 2O	00:00	00:00-23:59		Start time of the 2 nd time-section
		t 2F	00:00	00:00-23:59		Close time of the 2 nd time-section

		t 3O	00:00	00:00-23:59		Start time of the 3 rd time-section
		t 3F	00:00	00:00-23:59		Close time of the 3 rd time-section
	AH		OFF	ON/OFF		Thermostat function
		T_Sen				Sensor for thermostat function
		REL				Output for thermostat function
		AHO	40°C	0.0-95°C	0.5°C	Switch-on temperature
		AHF	45°C	0.0-94.5°C	0.5°C	Switch-off temperature
		t 1O	00:00	00:00-23:59		Start time of the 1 st time-section
		t 1F	00:00	00:00-23:59		Close time of the 1 st time-section
		t 2O	00:00	00:00-23:59		Start time of the 2 nd time-section
		t 2F	00:00	00:00-23:59		Close time of the 2 nd time-section
		t 3O	00:00	00:00-23:59		Start time of the 3 rd time-section
		t 3F	00:00	00:00-23:59		Close time of the 3 rd time-section
	BEEP		OFF	ON/OFF		Beeper function at cases like (sensor fault, over-pressure or low pressure, no flow OFLOW)

Auxiliary functions are set under “Aux” menu, controller can activate several auxiliary functions simultaneously.



Note: sometimes, the selected auxiliary function needs an input to connect an extra sensor and an output to connect a pump or electromagnetic valve. When there is no free input or output, this auxiliary function can't be triggered. And at such case, under the submenu, the auxiliary functions are already deactivated. Depend on the selected system; following functions may not be triggered.

● **SFB Solid fuel boiler function**

Solid fuel boiler function is used for transferring heat from a solid fuel boiler to a tank. It needs a sensor input (T_Sen) and an output (REL). The relay (system-dependent) is energized when all switch-on conditions are fulfilled:

- 1) The temperature difference between the sensor of heat source and the sensor of heat sink has exceeded the switch-on temperature difference (DTSFO).
- 2) The temperature at the solid fuel boiler sensor has exceeded its minimum temperature (MNSFO)
- 3) The temperature at the tank sensor has dropped below its maximum temperature (MXSFS)

When the preset temperature difference is exceeded, pump speed control starts. For every increase or decrease by the rise value, the pump speed will be adjusted by 10 %.

The switch-on hysteresis is when temperature drops 5 K.



Note: there is no solid fuel boiler function in system 14 ~ 20.

● **BYPR Solar circulation bypass function**

In some cases, it is good application to combine a temperature-controlled bypass circuit

into the solar circuit. In the time that tank is not heated by solar energy, this bypass circuit can avoid water from tank flows through the solar circuit (which may lead to reduce the tank's temperature). This function is also used to prevent freezing of flat plate exchanger, for this purpose, a sensor input (T_Sen) and output (REL) are needed to install in the system.

For example: in the morning, solar pump doesn't run, collector is heating by solar, but there is some cold solar liquid in the circulation pipe, in order to prevent this cold solar liquid flows into the tank or heat exchanger, 3-ways valve Rx will not be switched to the tank, until the temperature difference between Tx of inlet pipe of tank and T2 of tank temperature or T3 of flat plate heat exchanger exceeds the preset switch-on temperature difference, valve just is switched to the tank to transfer the heat from collector to tank.

Bypass circuit function needs an extra pump or valve (TYPE VALV= valve logic, TYPE PUMP= pump logic).

Switch-on conditions:

- Collector and tank meets the switch-on temperature difference (DTO)
- When bypass temperature Tx is higher than (tank temperature +DTF+2oC), 3-ways valve will be switched to heat the tank.
- When bypass temperature Tx is lower than (tank temperature +DTF), 3-ways valve will be switched to heat the bypass pipe.

Icon  displays on the screen, it means bypass function is activated.

Icon  displays on the screen, it means bypass function is in operation.

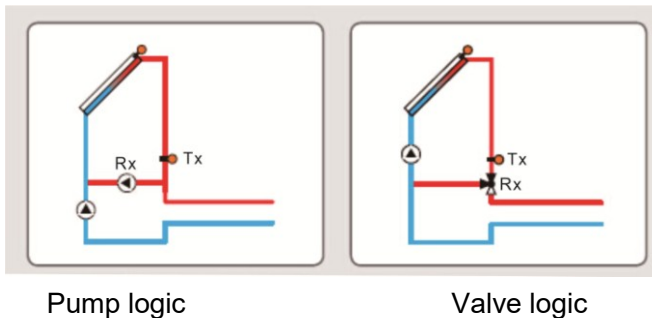

● **TIMER Timer function**

Timer function can trigger controller's output port at the pre-set time; therefore, an available output (REL) is needed.

Icon  displays on the screen, it means the timer function is activated.

Icon  displays on the screen, it means timer function is in operation.

● **AH After heating / Thermostat function**

The thermostat function works independently from the solar operation and is used for using surplus energy or for after heating. (Every day 3 heating time frames can be set)

Note:

AH O < AH F: Thermostat function used for after heating

AH O > AH F: Thermostat function used for releasing surplus energy from tank

Icon  displays on the screen, it means thermostat function is activated.

Icon  displays on the screen, it means thermostat function is in operation.

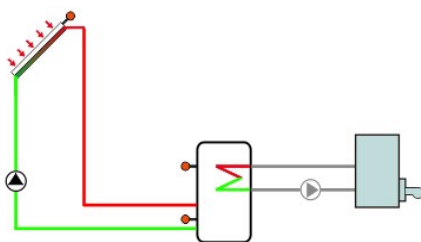

After heating

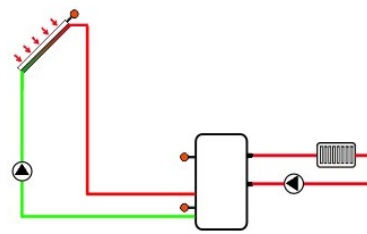

Energy releasing

● **BEEP Beeper fault warning**

When system has fault (temperature sensor fault, system over pressure, system low pressure, no flow), beep will send warning.

(17) MAN Manual function

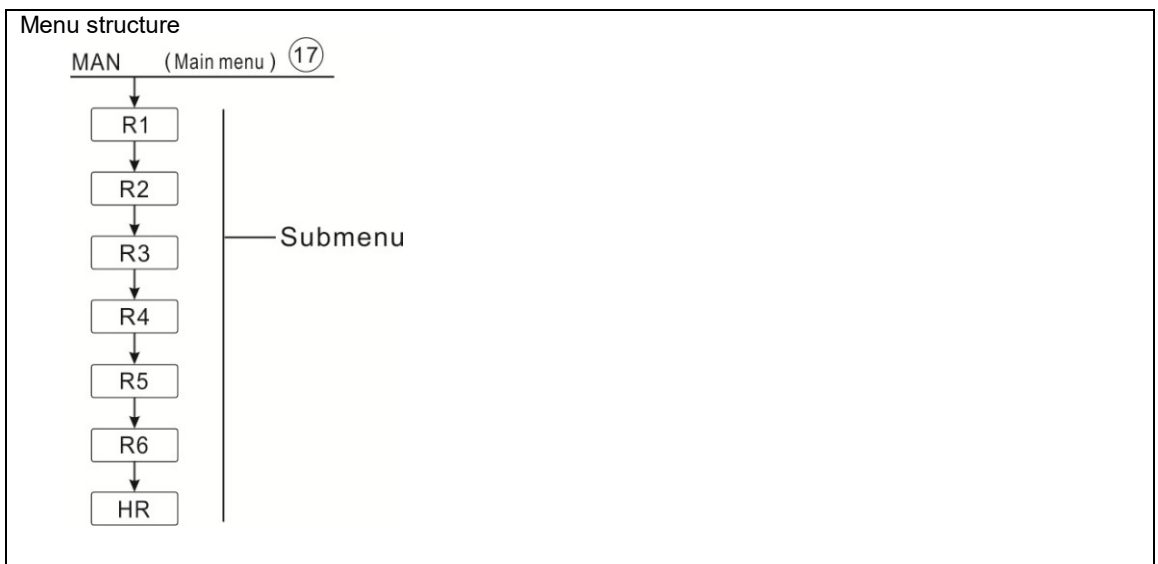

Main menu	Submen u 1	Submen u 2	Default setup	Adjust range	Adjust step	Description
MAN						Manual mode
	R1		OFF	ON/OFF		R1 relay on/off
	R2		OFF	ON/OFF		R2 relay on/off
	R3		OFF	ON/OFF		R2 relay on/off
	R4		OFF	ON/OFF		R2 relay on/off
	R5		OFF	ON/OFF		R2 relay on/off
	R6		OFF	ON/OFF		R2 relay on/off
	HR		OFF	ON/OFF		HR relay on/off

For control and service work, the operating mode of relays can be manually adjusted. For this purpose, select the adjustment menu MAN (for R1, R2, R3, R4, R5, R6, HR) to set manual output “On/OFF”.

i **Note:** Manual mode is activated, “MAN” displays on the screen, controller runs for 15 minutes and then switch-off all outputs, control exits manual mode automatically.

(18) BLPR Pump blocking protection

<p>Menu structure</p> <p>BLPR (Main menu) (18)</p> <p>↓</p> <p>BLPR ON Submenu</p>						
Main menu	Submen u 1	Submen u 2	Default setup	Adjust range	Adjust step	Description
BLPR			OFF	ON/OFF		Pump blocking protection function

In order to protect pumps from blocking after long time standstill, the controller is equipped with a blocking protection function. This function switches on pump relays in sequence every day at 12:00 a.m. and every pump runs for 10 s at 100 % speed.

When the pump blocking function is activated, count down of BLPR 01 ~ BLPR HR displays on the screen in sequence.

(19) OTDIS Thermal disinfection function

Main menu	Submenu 1	Submenu 2	Default setup	Adjust range	Adjust step	Description
OTDIS			OFF	ON/OFF		Thermal disinfection function on/off
	PDIS		7d	0-30d	1d	Monitor time frame of
	DDIS		10min	1-120	1min	Heat time frame of disinfection
	TDIS		70°C	0-90°C	1°C	Setting of disinfection temperature
	SDIS		18:00	00:00-21:00	1:00	Start time of disinfection

● **Thermal disinfection**

This function helps to prevent the spread of Legionella in DHW tanks by systematically activating the after-heating. One sensor and one relay can be selected for this function. For thermal disinfection, the temperature at the allocated sensor is monitored. This protection ensures the disinfection temperature exceeds the setpoint of disinfection temperature TDIS for the entire disinfection period DDIS. Thermal disinfection can only be completed when the disinfection temperature is exceeded for the duration of the disinfection period without any interruption.

The monitoring period PDIS starts as soon as the temperature at the allocated sensor falls below the disinfection temperature TDIS, once the monitoring period PDIS ends, disinfect period SDIS starts, the allocated relay activates the after-heating, and SDIS disinfect time count down “Disinfect 10” displays and flashes on the screen. If the temperature at the allocated sensor exceeds the disinfection temperature TDIS, thermal disinfection heating period DDIS starts, “Disinfect 10” count down time displays, count down time ends, thermal disinfection function stops.

(20) OPARR Parallel relay

Menu structure

```

    graph TD
      OPARR["OPARR (Main menu) 20"] --> PARRE
      PARRE --> INVER
      subgraph Submenu
        PARRE
        INVER
      end
  
```

Main menu	Submenu 1	Submenu 2	Default setup	Adjust range	Adjust step	Description
OPARR			OFF	ON/OFF		Parallel relay function on/off
	PARRE					Select parallel relay
	INVER		OFF	OFF/ON		Parallel relay on/ff

With this function, e. g. a valve can be controlled in parallel to the pump via a separate relay.

If solar heating takes place (R1 and / or R2) or if a solar function is active, the selected parallel relay will be energized simultaneously. the parallel relay can also energize the pump relay in reverse.

INVER OFF means R1/R2 is energized, parallel reply is also energized.

INVER ON, means R1/R2 is energized, but parallel reply is switched-off.

Icon  displays on the screen, it means parallel relay function is activated.

Icon  displays on the screen, it means parallel relay function is in operation.



Note: If R1 and / or R2 are in the manual mode, the selected parallel relay will not be energized.

(21) OHQM Heat quantity measurement

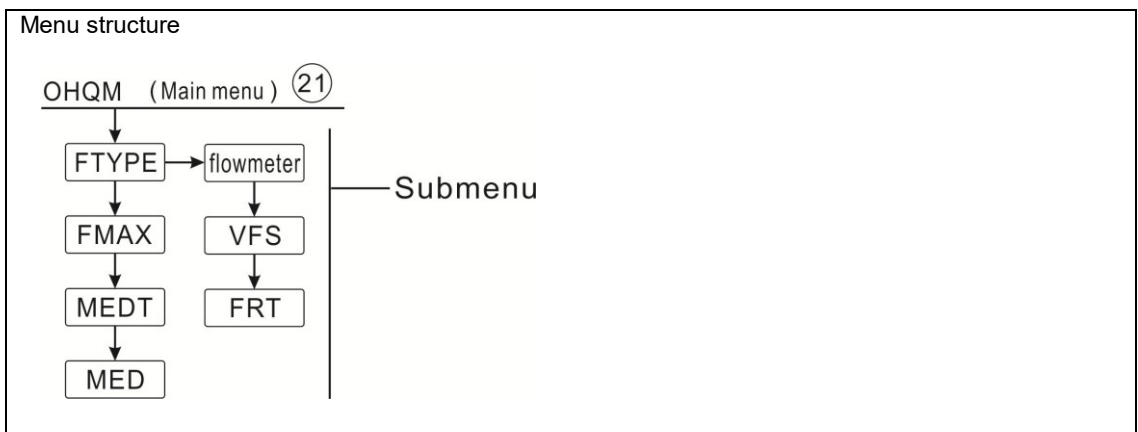

Main menu	Submenu 1	Submenu 2	Default setup	Adjust range	Adjust step	Description
OHQM			OFF	ON/OFF		Thermal energy measurement function on/off
	FTYPE					Select flow meter
		flowmeter	flowmeter			Fixed flow rate
		VFS				VFS Grundfos flow meter
		FRT				FRT Vane type flow meter
	FMAX		6L/min	0.5-100L/min	0.1	Enter flow rate
	MEDT		3	0-3		Heat transfer liquid 0: Water 1: Propylene glycol 2: Ethylene glycol 3: Tyfocol LS/G-LS;
	MED%		45%	20-70%	1%	Liquid concentration

- There are three methods to measure the heat quantity:

- 1) Fixed flow rate (with flow meter)
- 2) With Grundfos flow rotor VFS
- 3) With FRT vane type flow meter

- **Heat quantity measurement with fixed flow rate value**

The heat quantity measurement calculation (estimation) uses the temperature difference between the flow (T6) and return (T7) and the entered flow rate (at 100 % pump speed).

Note: sensor of flow and return pipe for heat quantity measurement is default set in every system, it cannot be set.

Under menu FTYPE to set the flow rate type 1

- ▶ Read the flow rate (l/min) and enter it in the **FMAX menu**
- ▶ Enter the antifreeze type and concentration of the heat transfer fluid under menu **MEDT** and **MED%**.

- **Antifreeze type:**

- 0: Water
- 1: Propylene glycol
- 2: Ethylene glycol
- 3: Typhcol LS / G-LS



Note: Heat quantity measurement is not possible in systems with 2 solar pumps.

- **Heat quantity measurement with Grundfos Direct Sensor VFS**

The heat quantity measurement uses the temperature difference between flow T6 and return TVFS and the flow rate transmitted from the VFS sensor.

TVFS: Grundfos Direct sensor VFS



Note:

- 1) Sensor of flow and return pipe for heat quantity measurement is default set in every system, it cannot be set.
- 2) Flow checking function is only available when a VFS type Grundfos Direct Sensor is connected to the system.
- 3) If select Grundfos sensor VFS to calculate heat quantity, firstly you should activate VFS function under menu GFDS, and select measurement range, default value is 1-12L/min.

Under menu FTYPE to set flow rate type VFS and measurement range, default is 1-12L/min

▶ Adjust the antifreeze type and concentration of the heat transfer fluid under menu **MEDT** and **MED%**

▶ For the systems with 2 collector fields, sensor should be installed on the manifold flow and return pipe for heat quantity measurement

T6: Flow sensor

TVFS: Return sensor

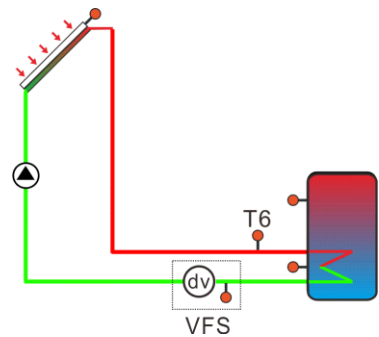

Display unit of heat quantity for current day is DkWh, Accumulated heat quantity displays as kWh or MWh, sum of current day quantity and accumulated quantity becomes total energy output.

● **Heat quantity measurement with Vane type flow meter (FRT)**

Under menu FTYPE to set flow rate type FRT

The heat quantity measurement uses the temperature difference between flow T6 and return T7 and the flow rate transmitted from the FRT sensor.

Adjust the antifreeze type and concentration of the heat transfer fluid under menu **MEDT** and **MED%**

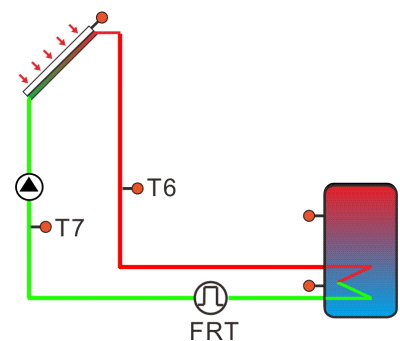

(22) FS Flow meter type selection

Main menu	Submenu 1	Submenu 2	Default setup	Adjust range	Adjust step	Description
GFDS						Register Grundfos sensor
	VFS		OFF	OFF / ON		Grundfos flow sensor
		1-12				Measure range of Grundfos flow meter (1-12 L/min)
		2-40				Measure range of Grundfos flow meter (2-40 L/min)
	FRT		OFF	OFF / ON		Vane type flow meter
	OFLOW		OFF	ON/OFF		NO flow warning
	DELAY		30s	1-600s	1s	Inspection time for no flow warning
	RPS		OFF	OFF/0-10bar		Grundfos pressure sensor

Under this menu, the Grundfos direct sensor (VFS, RPS) can be activated or deactivated, and its measurement range can be set.

● **Flow rate monitoring (OFLOW)**

The flow rate monitoring function (OFLOW) is used for detecting malfunctions that impede the flow rate and for switching off the corresponding tank. This will prevent system from damage, e. g. through a dry run of the pump.

If the allocated relay is energized, the flow rate will be monitored at the allocated sensor. An error message will appear when no flow rate is detected at the allocated sensor after the delay time (DELAY) has passed.

If the shutdown option has been activated for the flow rate monitoring function, the tank being heated will be blocked for any further heating until the error message has been acknowledged, next tank as the substitution will be heated instead, if possible. When the error message has been acknowledged, the monitoring function will be active again.

i Note: If the flow rate sensor used for this function is removed, flow rate monitoring will be deactivated.

(23) PRESS Pressure monitoring

Main menu	Submenu 1	Submenu 2	Default setup	Adjust range	Adjust step	Description
PRESS						Pressure monitoring
	OOVPR		OFF	ON/OFF		Warning due to system overpressure
		OVPRO	5.5bar	0.6-6bar	0.1bar	
		OVPRF	5.0bar	0.3- 5.7bar	0.1bar	
	OLEAK		OFF	ON/OFF		Warning due to system low-pressure
		LEAKO	0.7bar	0.3-5.7bar	0.1bar	
		LEAKF	1bar	0.6-6bar	0.1bar	

i Note: The pressure monitoring function will only be available when an RPS type Grundfos Direct Sensor™ is connected.

The pressure monitoring function is used for detecting overpressure or low-pressure conditions inside the system, and if necessary, to shut down the affected system components to avoid system damage.

● **Overpressure (OOVPR)**

If the system pressure exceeds the adjustable switch-on pressure of valve (OVPRO), an error message will appear.

If the shutdown option has been activated for the overpressure monitoring function, the solar system will be shut down as well when there is a fault condition. When the pressure reaches or falls below the adjustable switch-off pressure (OVPRF), the system is switched on again.

i Note: For the overpressure monitoring function, the switch-on pressure must be at least 0.1bar higher than the switch-off pressure. The adjustment ranges will automatically adapt to that.

● **Low pressure (OLEAK)**

If the system pressure falls below the adjustable switch-on pressure of valve (LEAKO), an error message will appear.

If the shutdown option has been activated for the low-pressure monitoring function, the solar system will be shut down as well when there is a fault condition. When the pressure

reaches or exceeds the adjustable switch-off pressure, the system is switched on again.



Note: For the low-pressure monitoring function, the switch-off pressure must be at least 0.1bar higher than the switch-on pressure. The adjustment ranges will automatically adapt to that.

(24) UNIT C- F Temperature unit switch

Menu structure

Main menu	Submenu 1	Submenu 2	Default setup	Adjust range	Adjust step	Description
UNIT						
	TEMP		°C	°C/F		C-F temperature unit switch
	BAR		bar	bar/psi		Pressure unit switch
	ENERG		Wh	Wh/BTU		Thermal energy unit switch

Under this menu, below unit can be set:

TEMP: temperature

BAR: pressure

ENERG: heat quantity

The units can be switched during operation.

(25) OSDC SD card

Menu structure

Main menu	Submen u 1	Submen u 2	Default setup	Adjust range	Adjust step	Description
OSDC						SD card
	SAVE		YES			Store the controller adjustments on the MicroSD card,
	LOAD		YES			Uploading controller adjustments
	LOGI		01:00	01-23:59		Adjust the desired logging interval
	REMC		YES			Completing the logging process, take out the card from the slot
	FORM		YES			Formatting the SD card
	C_BMP		YES			Delete all system diagrams

The controller is equipped with a MicroSD card slot for MicroSD memory card.

With a MicroSD card, following functions can be carried out:

- Logging measurement and balance data: After transferring the data to a computer, the data can be opened and visualized, e. g. in a spreadsheet.
- Backup and retrieve the setting and parameter data: save the setting data and parameters of controller on the MicroSD card, and if necessary, retrieve them from SD card to the controller RAM.

When the SD card is inserted in the card slot, MicroSD card icon will display on the screen, if card is full, warning info will display on the screen, and under checking interface, there is also remind message that card is full.

● Running firmware updates

The current firmware software can be updated, in order to run an update, firstly to switch-off the power of controller, insert the MicroSD card with a firmware update program into the slot, and hold down “HOLIDAY” button to switch-on power again. The update enquiry message appears on the screen (according to the different case, content of message is different, if only firmware should be updated, then only update firmware message shows, if pictures should also be updated, then there is also picture update message appears)

Press “SET” button to confirm the update, then update is start.

- Update is automatic running, after update, following hint and press “SET” to restart controller, to entry the main program.
- If you want to jump over the update, please press “ESC”, controller will reboot its normal operation.
- If operation is wrong, just repower controller and repeat the update process.



Note: The controller will only find a file named "SR1568.bin" for the firmware update on the root directory of MicroSD memory card, find the file named BmpList.txt to update the diagrams.

● **Starting logging**

- Insert the MicroSD card into the slot, Logging will start immediately.
- Adjust the desired logging interval under menu OSDC-LOGI.

● **Completing the logging process (REMC)**

- Select the menu item **REMC**, “YES” displays, press “**SET**” to move the cursor to “**YES**”, continues press “**SET**” to run the extract card order, running finished, “SUCC” will displays, then card can be taken out.

● **Formatting the MicroSD card (FORM)**

- Select the menu **FORM**, “YES” displays, **press “SET”** to move the cursor to “**YES**”, continues press “**SET**” “WAIT” displays, formatting order starts to run, it lasts ca. 10 seconds, running finished, “SUCC” will displays, the content of the card will be deleted and the card will be formatted with the FAT file system.

● **Log controller adjustments (SAVE)**

- Select the menu item **SAVE** to save the setting on the SD card.
- Select the menu item **SAVE**, “YES” displays, **press “SET”** to move the cursor to “**YES**”, continues press “**SET**” to run save order, running finished, “SUCC” will displays.
- The controller adjustments are saved in “SR1568.DAT” file on the MicroSD card.

● **Uploading controller adjustments (LOAD)**

- To upload controller adjustments from an SD card to controller, firstly find the file named “SR1567.DAT” on SD card, and then select the menu **LOAD**. “YES” displays, press “**SET**” to move the cursor to “**YES**”, continues press “**SET**” to run file uploading, and then SUCC will be indicated on the screen.

● **Clear all system's pictures(C_BMP)**

- When system pictures appear errors, you can delete all the pictures from the flash card, while pictures are deleted. Select menu C_BMP, "YES" displaying, press "SET" cursor will move to "YES", continuously press "SET" to run delete process, after deleting, "SUCC" displays on the screen.
- Note: after pictures are deleted, please copy the pictures again from SD card to controller.



Note: controller support MicroSD with maximum size of 32G, under OSDC menu, if “SAVE”、 “LOAD”、 “REMC”、 “FORM” functions run successfully, at end of every process, “SUCC” displays, then you can no longer run these functions, but you can exit this menu and reenter, then such functions can be reactivated.

(26) RESET Reset

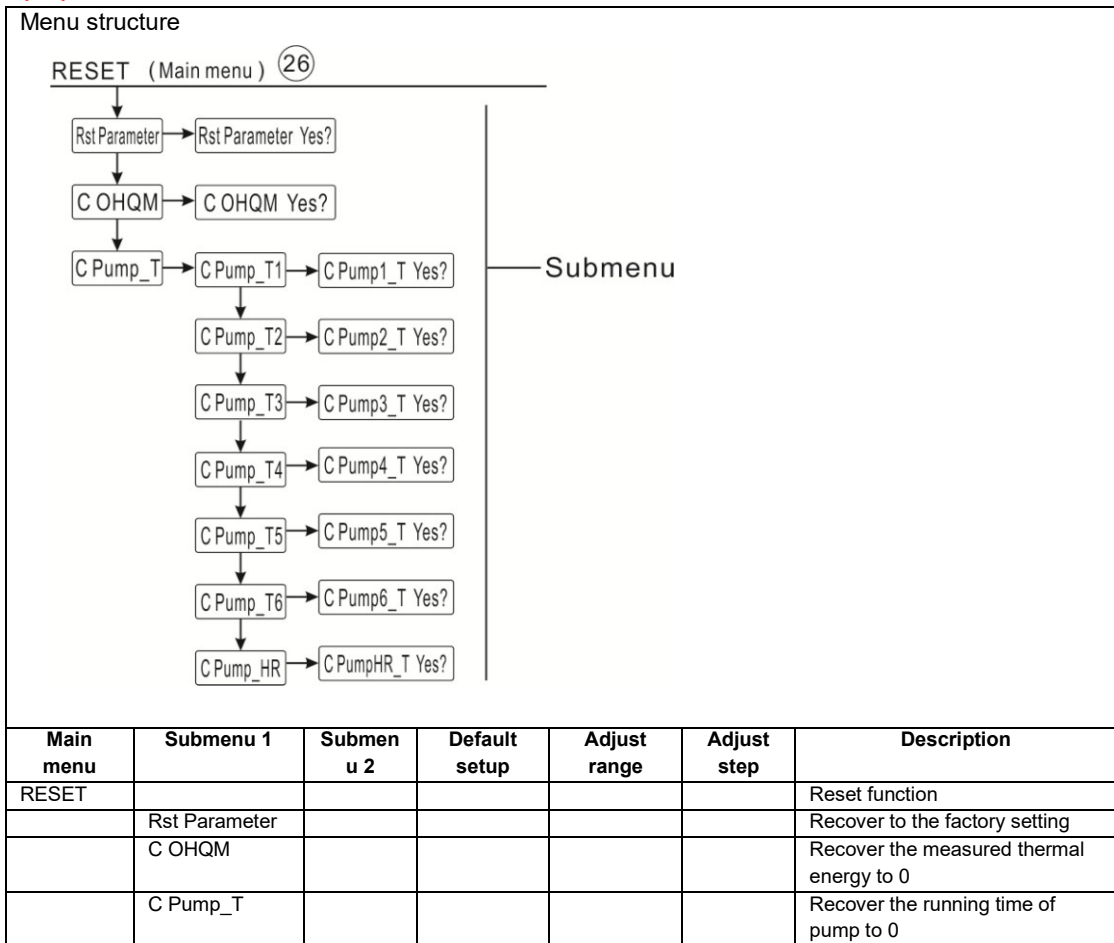

- Rst Parameter: Reset function, all settings can be recovered to the factory settings
- C OHQM: Accumulated heat (include dHQM) can be reset to 0
- C PUMP-T: Accumulated pump running time (R1time/ R2time/ R3time/ R4time/ R5time) /R6time/HRtime) can be reset to 0

(27) PASS Password set

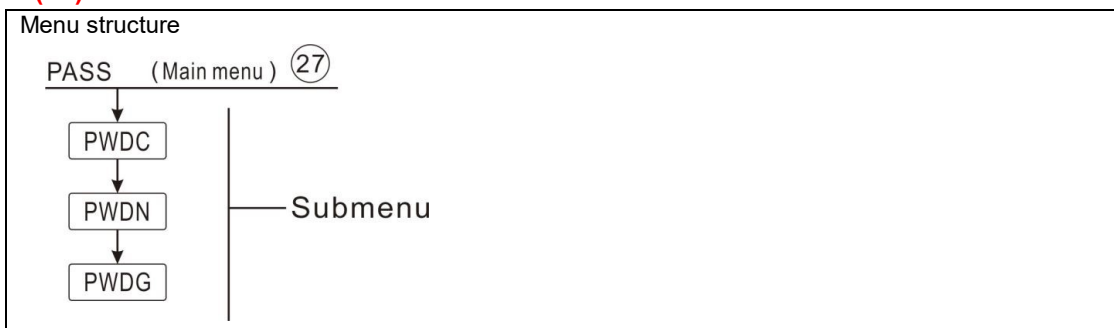

Main menu	Submen u 1	Submen u 2	Default setup	Adjust range	Adjust step	Description
PASS						Password set
	PWDC		0000			Enter current password
	PWDN					Enter new password
	PWDG					Reenter new password

Select password set menu "PASS"

- ▶ Press "SET" button, "PWDC 0000" displays on the screen, current password is asked to be entered. (Factory default password: 0000)
- ▶ Press "SET" button, "PWDN 0000" displays on the screen, enter a new password
- ▶ Press "SET" button, "PWDG 0000" displays on the screen, reenter the new password, and confirm the new password.
- ▶ Press "ESC" button to exit the setting, new password is set successfully.



Note: If the password is forgot, it is impossible to be recovered, but you can recover the password to the factory setting, then you can reedit a password like above steps, doing like following to recover to factory set

- ▶ Switch-off the power to controller
- ▶ Hold down "ESC" button
- ▶ Reconnect the power supply, and then release "ESC" button, controller recovers to the factory setting (factory set password is 0000)

6 Holiday function

The holiday function is used for operating the system when no water consumption is expected, e. g. during a holiday absence. This function cools down the system in order to reduce the thermal load.

2 cooling functions are available: tank cooling (OSTC) and tank heat transfer (OHDP). Controller is designed to run tank heat transfer (OHDP) function firstly, when tank heat transfer (OHDP) function is deactivated, then tank cooling function (OHTC) runs automatically in sequence.

Activate / deactivate holiday function

- ▶ Press "Holiday" button for 3 seconds, "Holiday 7 Days" displays.
- ▶ Press "↑", "↓" button to adjust days of holiday, adjust range 0-99 days.
- ▶ Repress "Holiday" button for 3 seconds, adjust days of holiday is "0" day.
- ▶ Press "ESC" button to exit, holiday function is deactivated.



Note: when you return from holiday, please deactivate this function in time.

7 Software of controller upgrade

- 1) Please copy the file like SR1568.bin and *.dta to the root directory of Micro SD Card. See screen snap below.

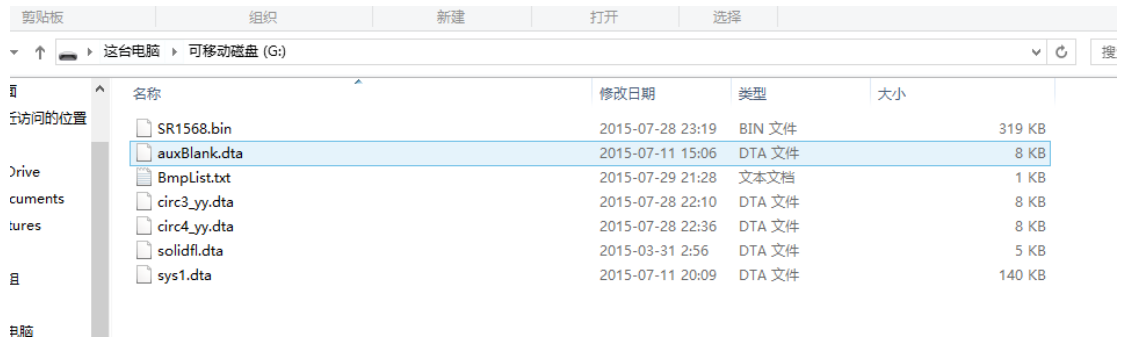

A. Switch-off the power and insert card to the controller, then hold on button “HOLIDAY”, and reconnect power to controller. Then the screen will show “Upgrade Picture and Firmware?” there are four possible questions to show in sequence, please check the FAQs.

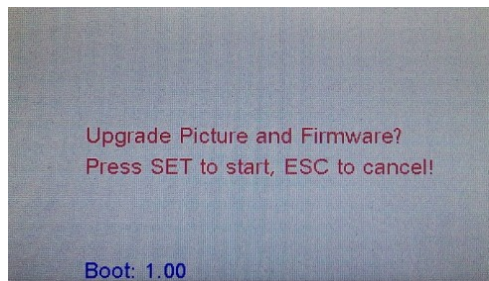

2) Press “SET” button to confirm upgrade, if there are updated file in card, screen will show red hint “Updating Picture”, blue word “working” will flash at the top of screen.



3) When upgrading is finished (depending on the size and quantity of files, running time is different), “Updating Picture OK” will show.

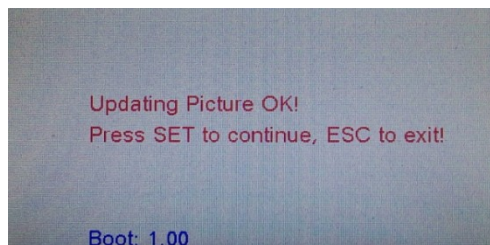

- 4) Press “SET” button to continue to upgrade firmware. Press “ESC” to exit upgrading and return to control system.
- 5) When Pressed “SET”, after 3 seconds, display appears “Update Success! Press SET to restart”, it indicates the upgrading is successful. Press “SET” or “ESC”, the controller will return to the control system.

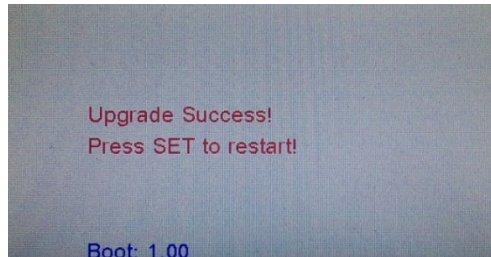

- 6) After the controller return to the system, please check the new version.



Note: Does not power off the controller during the upgrading!

- 7) If the screen shows “Update Failure! Please try again!”, please check the files in TF Card, and do again following above step or call our technician for support.

FAQs:

String in screen	Reason
Please Insert TF Card!	The card is not inserted or not correct.
No valid files in TF Card!	Please check the files in card, update the files, and try again. Please make sure the format of the card is FAT.
Update Picture?	Only update pictures from Micro SD card
Update Firmware?	Only update firmware from Micro SD card
Update Failure! Please try again!	Upgrade firmware failure, copy files from PC to Micro SD card again, and try to upgrade firmware again. Or call our technician for support.

8 Protection function

8.1 Screen protection

When no any press on button for 6 minutes, screen protection is activated automatically, and then LED background lamp is switched-off. Through press any button to light LED lamp again.

8.2 Trouble protection

When there is a break or short circuit between the connection of temperature sensors, flow meter and pressure sensor, controller switches off the corresponding functions and no more output signals are given, at the same time error signal  appears on the screen. And indicate lamp flashes.

► Press “↑” “↓” button to view the error message (red indication)

Error code:

T	Sensor fault
VFS	Grundfos flow meter fault
TVFS	Grundfos flow-temperature sensor fault
RPS	Pressure sensor fault
NOFL	No flow fault
HRPS	High pressure fault
LRPS	Low pressure fault

8.3 Trouble checking

The built-in controller is a qualified product, which is conceived for years of continuous trouble-free operation. If a problem occurs, the most of causes is from the peripheral components but no relation with controller itself. The following description of some well-known problems should help the installer and operator to isolate the problem, so that the system can be put into operation as quickly as possible and to avoid unnecessary cost. Of course, not all possible problems can be listed here. However, most of the normal problems encountered with the controller can be found in the list below, only return the controller to seller when you are absolutely sure that none of the problems listed below is responsible for the fault.

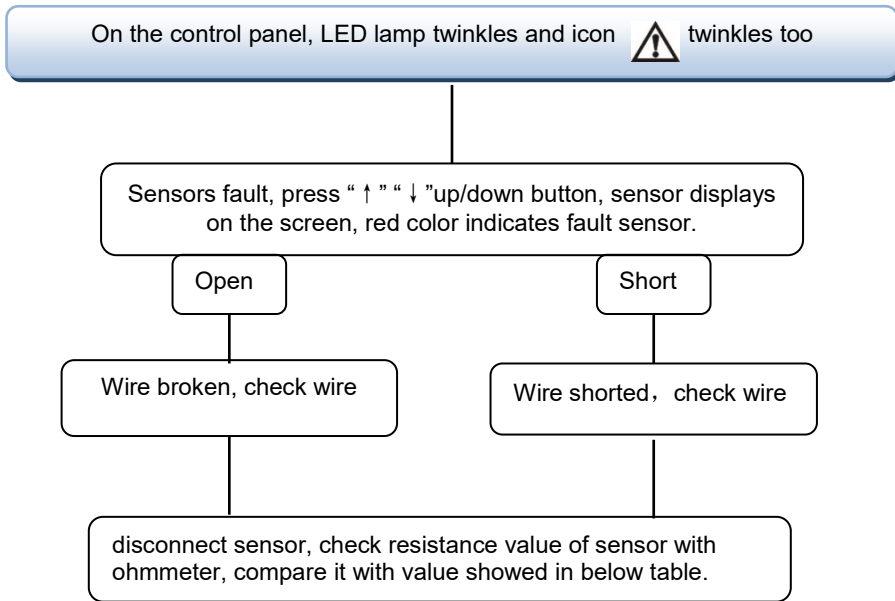

PT1000 resistance value

°C	0	10	20	30	40	50	60	70	80	90	100	110	120
Ω	1000	1039	1077	1116	1155	1194	1232	1270	1309	1347	1385	1422	1460

°C	0	10	20	30	40	50	60	70	80	90	100	110	120
Ω	33620	20174	12535	8037	5301	3588	2486	1759	1270	933	697	529	407

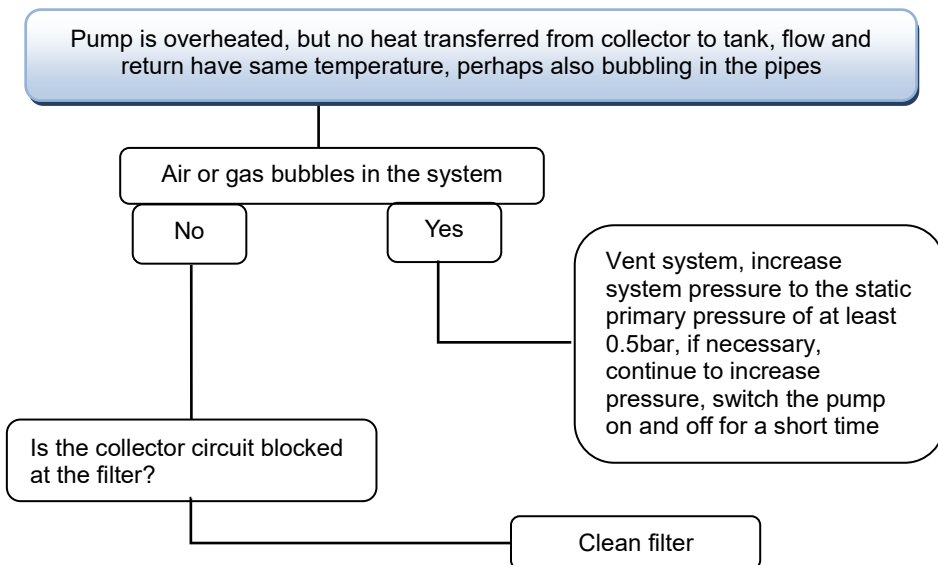
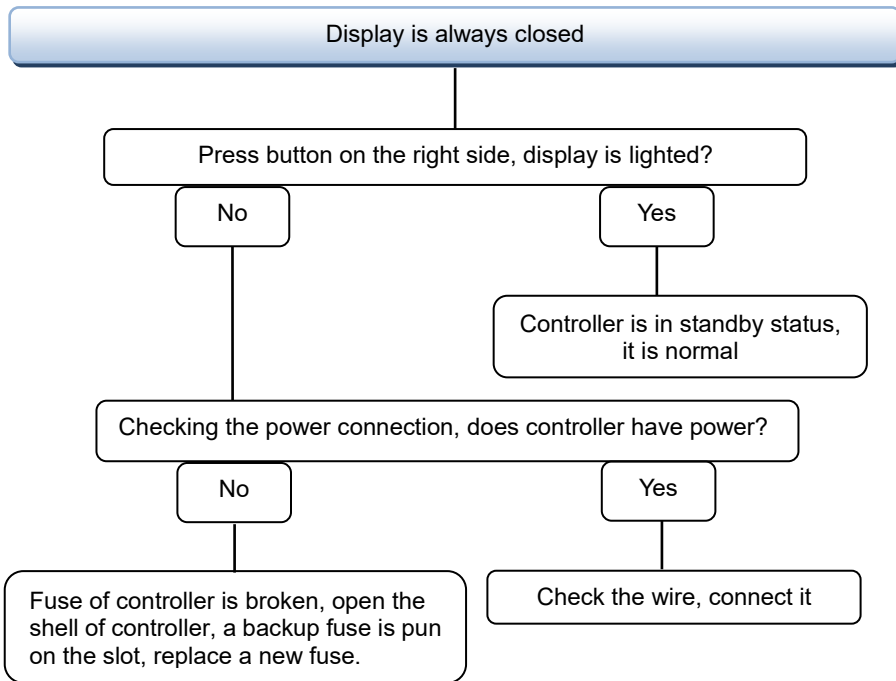

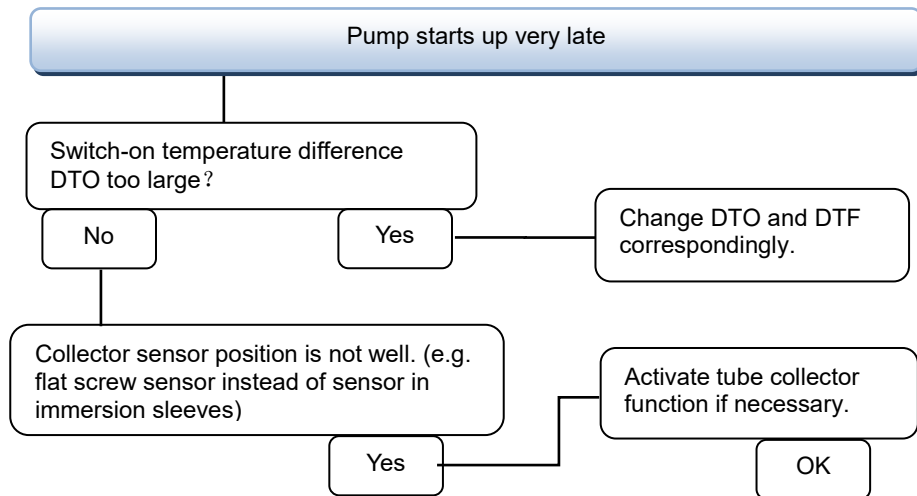
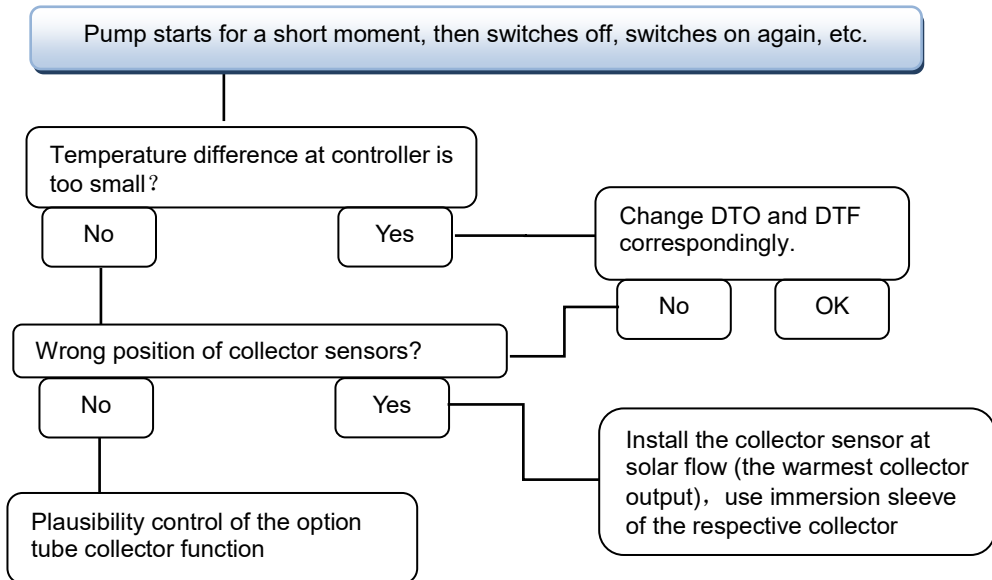

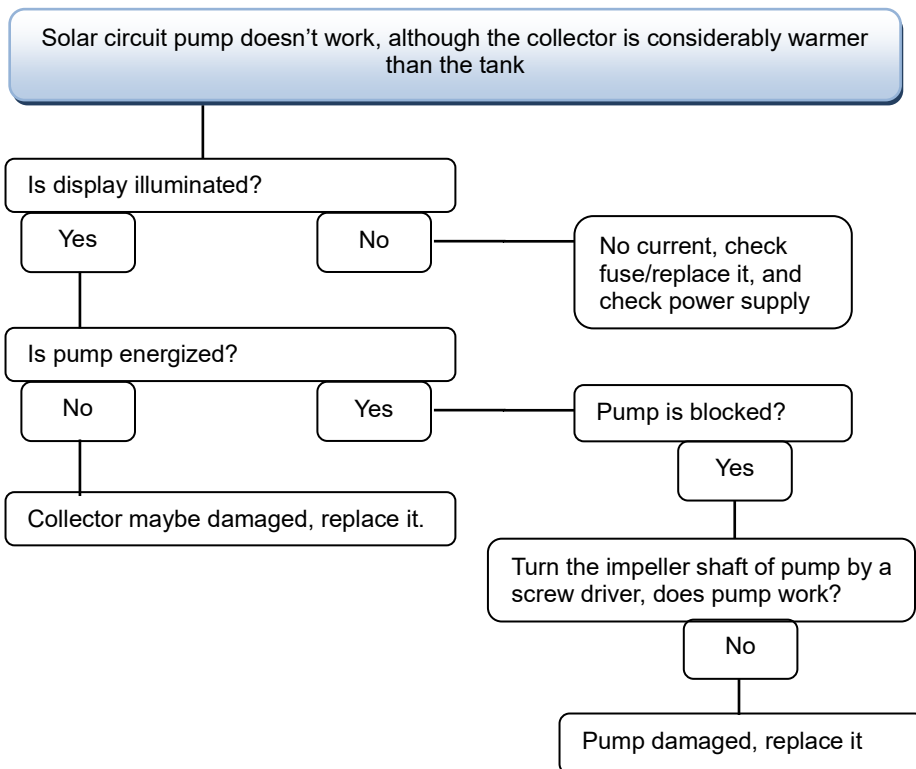
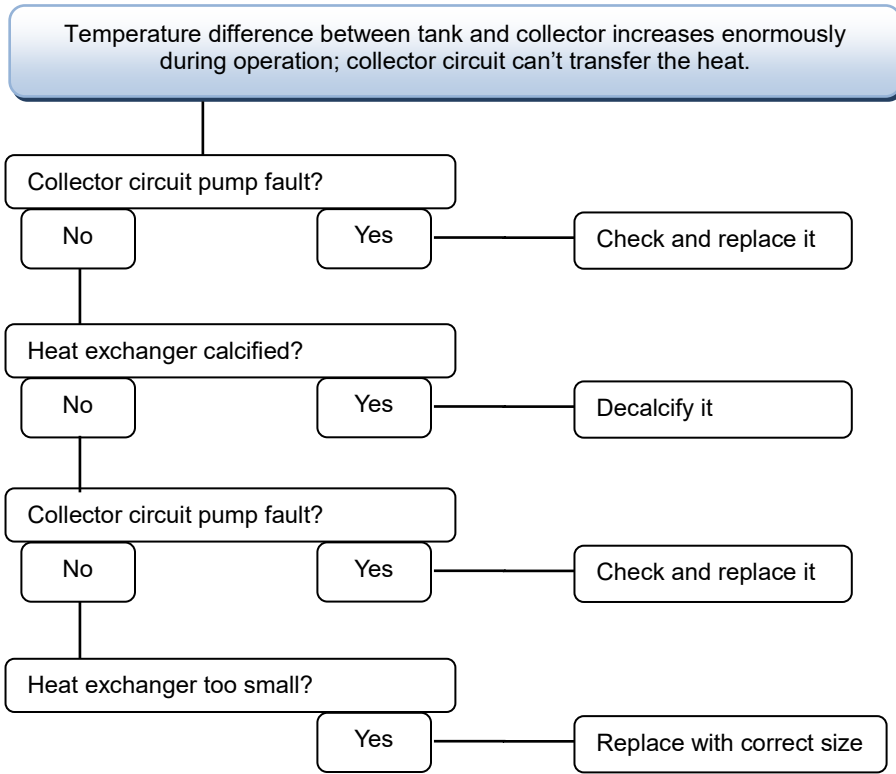

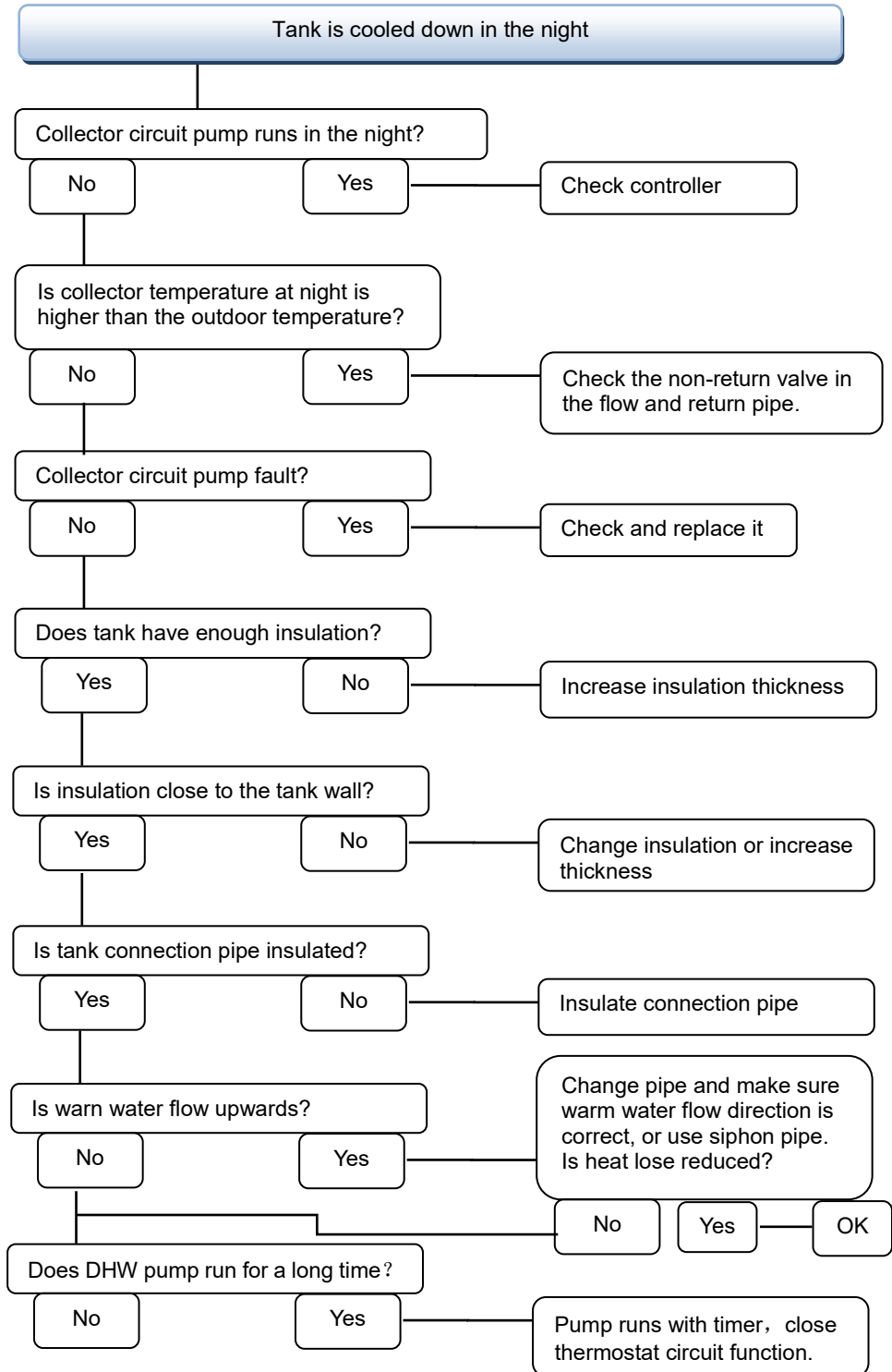

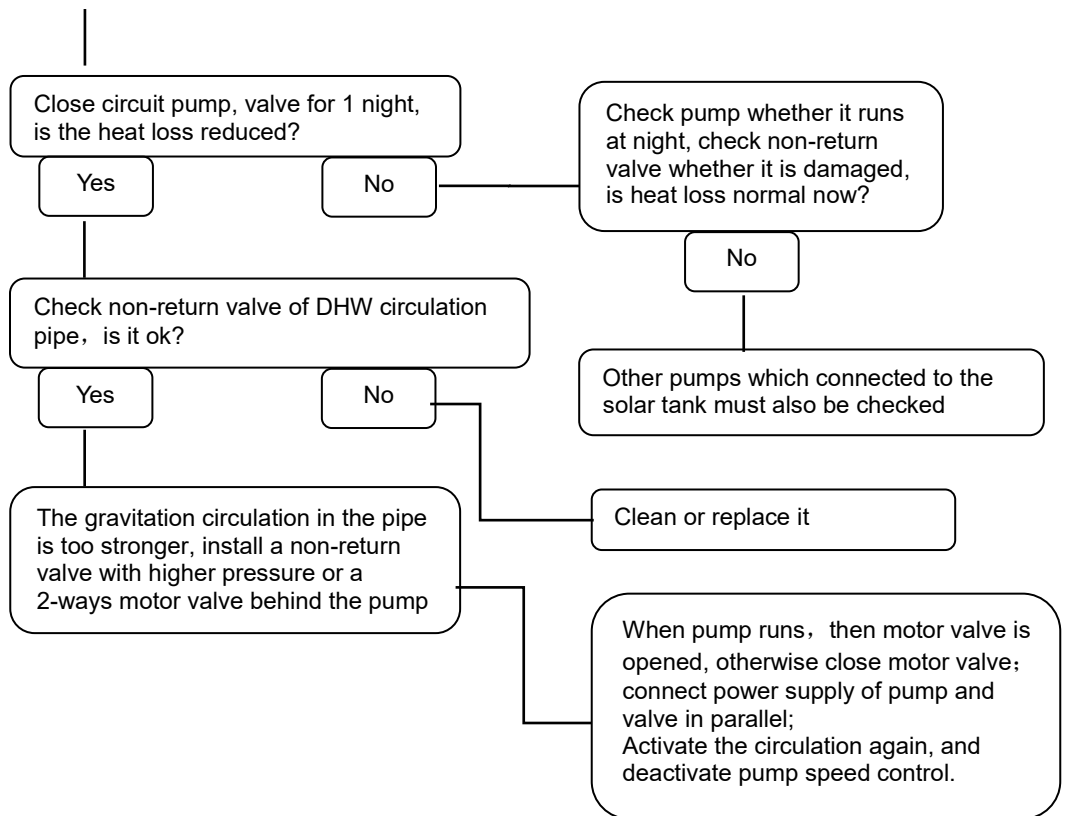





9 Quality Guarantee

Manufacturer provides following quality responsibilities to end-users: within the period of quality responsibilities, manufacturer will exclude the failure caused by production and material selection. A correct installation will not lead to failure. When a user takes incorrect handling way, incorrect installation, improper or crude handling, and wrong connection of Warm water outflow upwards?

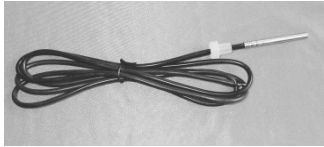
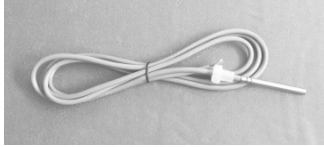
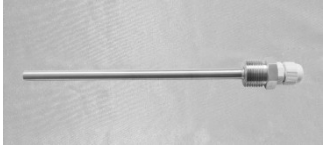
The quality warranty expires within 24 months after the date of purchasing the controller.

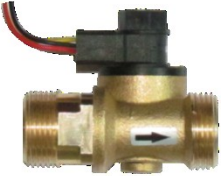
10 Accessories

Products name	Specification	Products picture
A01: High accurate Pt1000 sensor for collector	PT1000, $\Phi 6 \times 50$ mm, with 1.5m cable	
A02 High accurate sensor for tank and pipe NTC10K	NTC10K, B=3950, $\Phi 6 \times 50$ mm, with 3m cable	
A05 304 stainless steel thermo well	304 stainless steel with thread 1/2" OT, Size: $\Phi 8 \times 250$ mm	
A13 Grundfos Direct Sensor VFS	1-12l/min	
A14 RPS Grundfos pressure sensor		
A17 FRT digital flow meter	Thread male: 3/4 Power: 5-24V/DC	
A18 HT-30 flow switcher	Maximum voltage: < 110 V Minimum voltage: > 0 V Rated voltage: 0-24V Maximum current: 200mA Rated current: 100mA initiate flow: > 0.7 L/minute	

Operation manual of solar controller SR1568

	Fluid type: water or similar liquid Pressure of fluid: <0.6Mpa Temperature of fluid: <100°C	
SR802 Unit for high power electrical heater	Dimension:100mm*100mm*65mm Power supply: AC180V ~ 264V, 50/60Hz Suitable power: ≤ 4000W Available ambient temperature: -10 ~ 50°C Waterproof grade: IP43	